

Olaf T. Berglihn, Inga M. Aasen, Bernd Wittgens,
SINTEF Materials and Chemistry

Conversion of Seaweed to Biofuels: Potential and Challenges

Workshop – Seaweed for Biofuel
Trondheim 25. September 2012



Outline

- Refining of biomass to fuels – overview.
- Fuels from seaweed.
- Seaweed vs. Lignocellulosic material.
- Alginate conversion challenges.
- Separation challenges.
- To industrial scale.
- Current research and outlook.

The Biorefinery Concept

Oil refinery

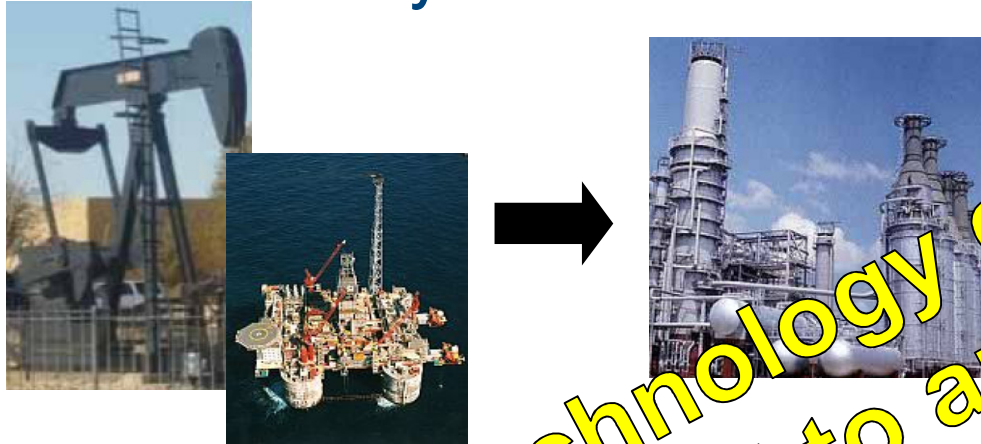

Biorefinery



Generic technology developed over 40 years applied to an emerging market

- Products
 - Heat & Power
 - Motor Vehicle Chemicals



Current Status of Biofuel Production Technologies

Technology	Laboratory	Pilot plant	Demonstration plant	Market
Sugar/starch ethanol				
Biodiesel - esters				
Lignocellulosic ethanol				
Biobutanol				
Algae biodiesel – lipids to esters				

Biorefinery Pathways

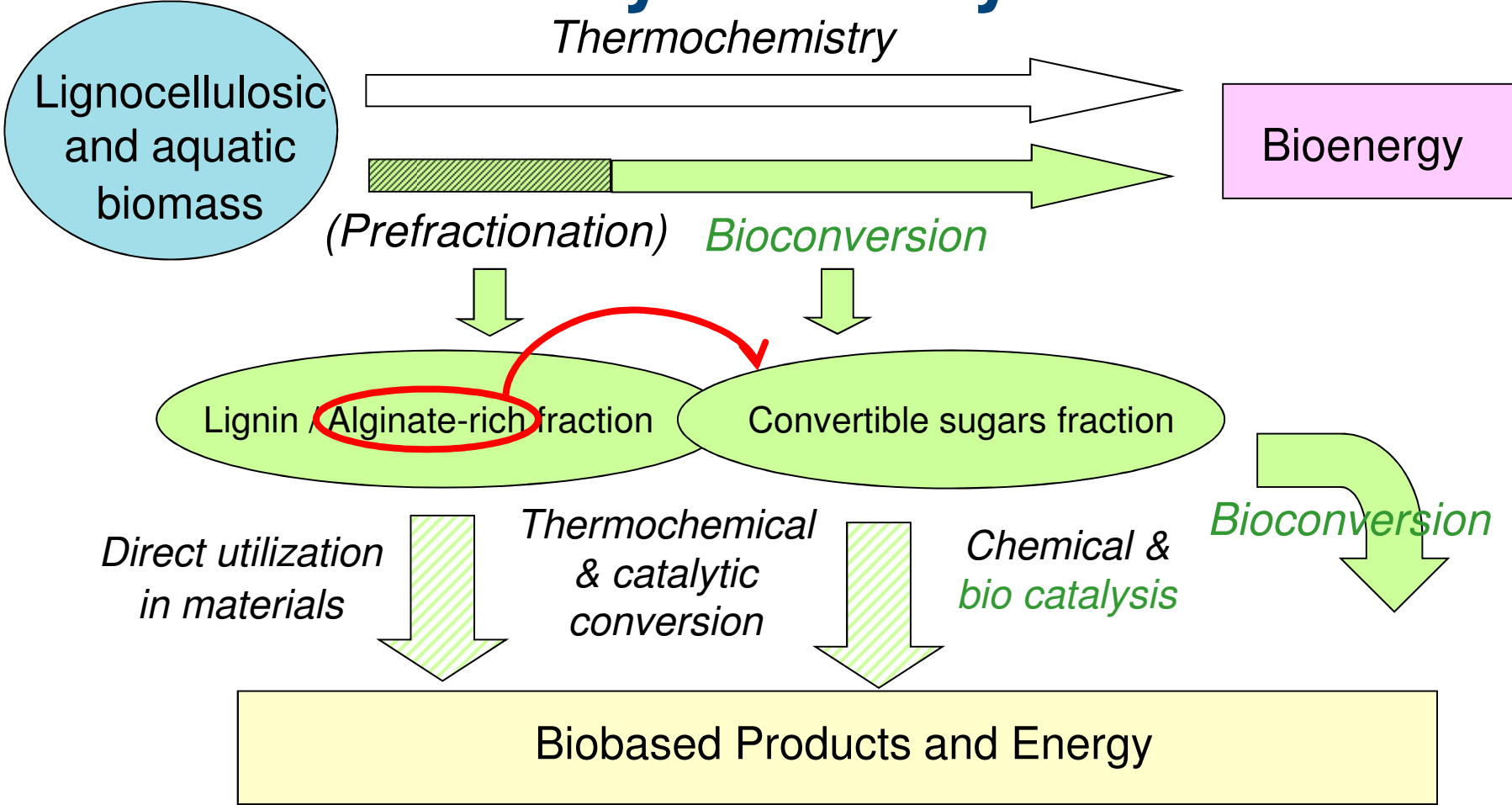

Fuels from Carbohydrates

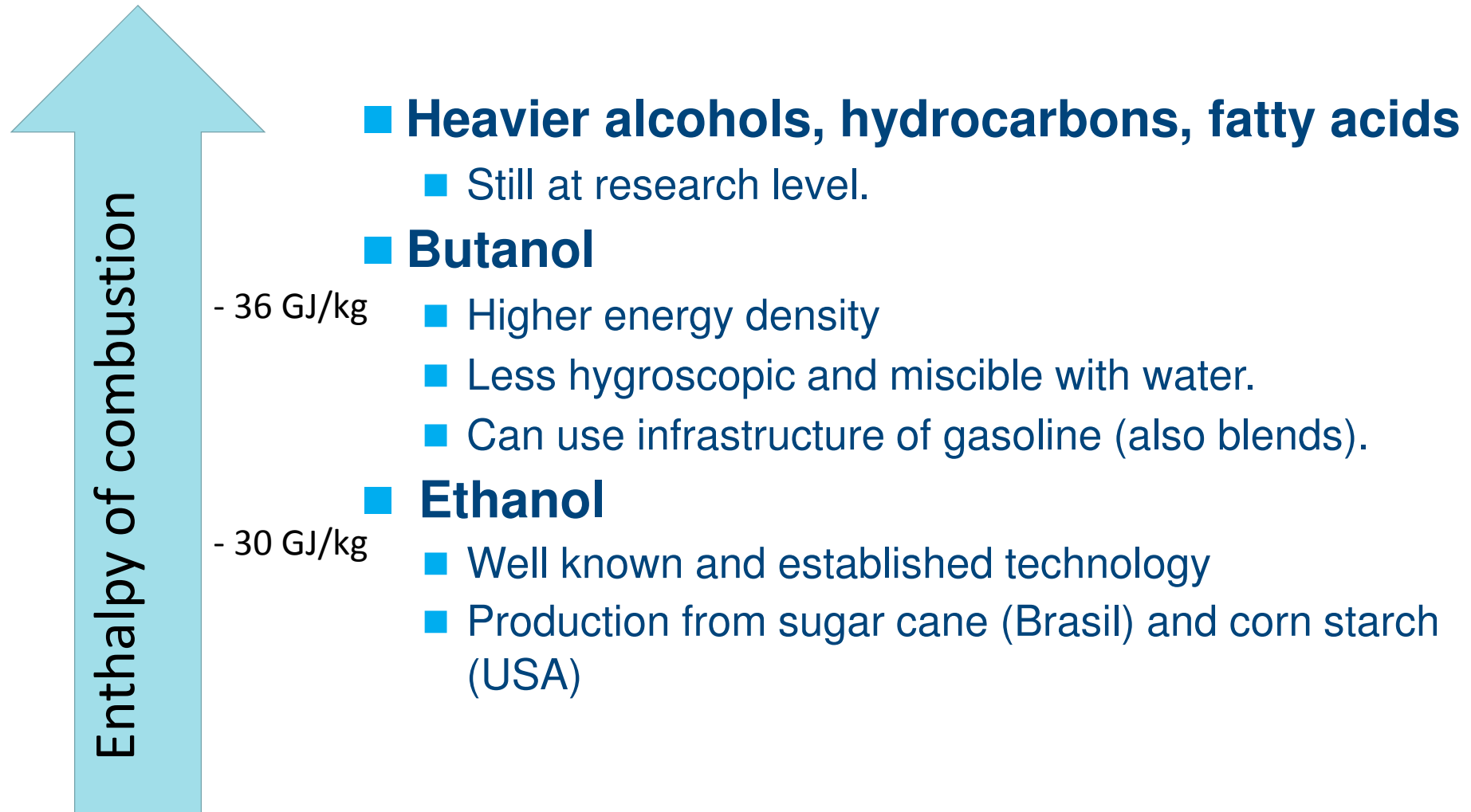

Biofuels from Seaweed

■ Some attractive properties of seaweed

- High sugar content.
- No lignin.
- No fresh water requirement.
- Does not claim land area for growing.

■ ... and some disadvantages

- High water content.
- Seasonal variations.
- Heterogeneous composition – Some carbohydrates are less susceptible to anaerobic conversion.

Seaweed vs. Lignocellulosic Material (1)

- **Other sugars than in land based biomass:**
 - Laminarin
 - Chemical, enzymatic or microbiological hydrolysis to glucose.
 - Fermentation of all relevant microorganisms to relevant products.
 - Mannitol
 - More reduced than glucose.
 - Oxidized to fructose and converted via glycolysis.
 - Fermentation to ethanol and CO₂ as the only products are not possible due to redox imbalance.
 - Alginate

Seaweed vs. Lignocellulosic Material (2)

Component	Carbohydrate content -- % of dry weight			Ethanol theoretical yield [g/g]
	Brown algae (Sea Belt)	Straw	Spruce	
Cellulose		35	44	0.57
Hemicellulose		32	23	0.57
Laminarin	25			0.57
Mannitol	15			0.51
Alginate	20			0.44
Other carbohydrates	10			
Sum carbohydrates	70	67	67	

Raw material	Theoretical maximum ethanol yield	
	[g/g dry weight]	[L/1000 kg dry weight]
Brown algae	0.36	456
Straw	0.34	430
Spruce	0.38	487

Alginate Metabolic Pathway

- A high number of marine microbes can utilize alginate by aerobic processes.
- Enzymatic hydrolysis:
 - Lyase yields reduced sugar (DEH).
 - Fermentation to ethanol and CO₂ as the only products are not possible due to redox imbalance.
 - Microbes that are able to ferment alginate yield mainly organic acids.
- Acid hydrolysis gives uronic acid.
 - Uptake and metabolism available?

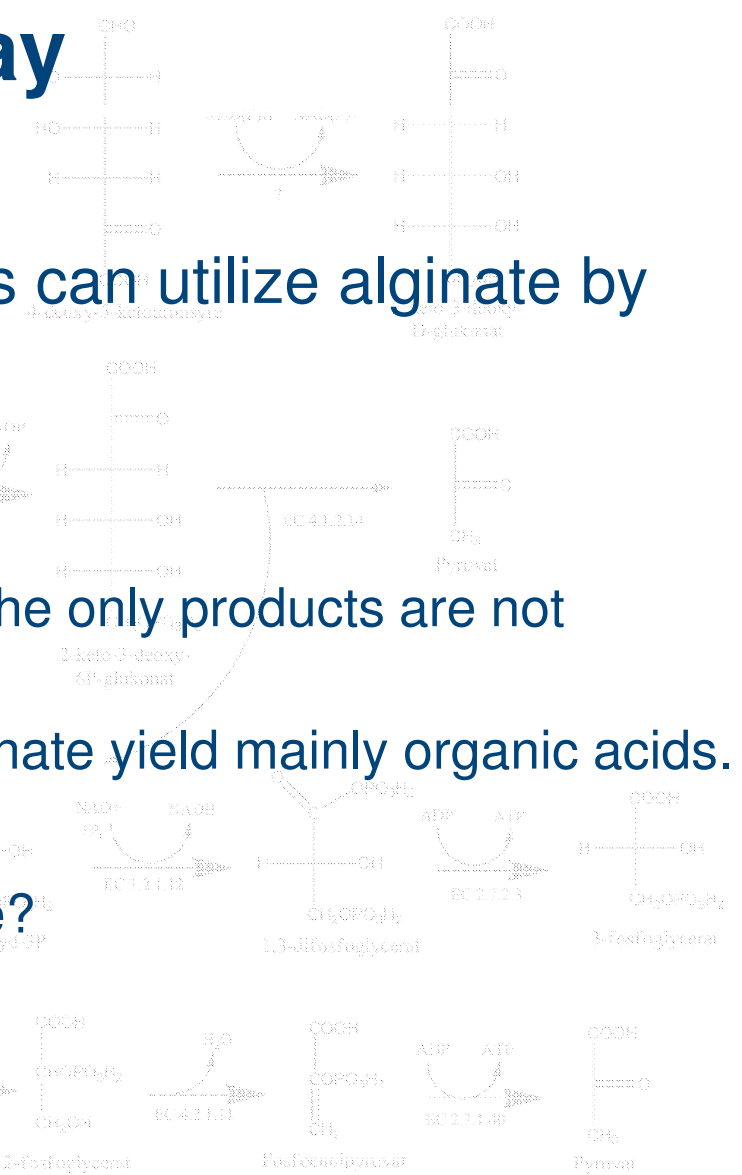

Ethanol from Alginate

- Redox-balance
 - Need to combine substrates.
- Gene manipulation of microorganisms.
 - Alginate degrading bacteria have been gene manipulated to produce ethanol (Takeda et al., Energy Environ. Sci, 2011).
 - Cloning of lyase, uptake and enzymes for further conversion in ethanol producing organism
 - Not yet achieved?
 - Clone "everything" in any organism (Wargacki et al., *Science* 20 January 2012).

Conversion Challenges

- Processing is simpler than for lignocellulosic biomass
- But: alginate will represent 1/3 or more of the carbohydrates.

→ Need to make use of all carbohydrates.

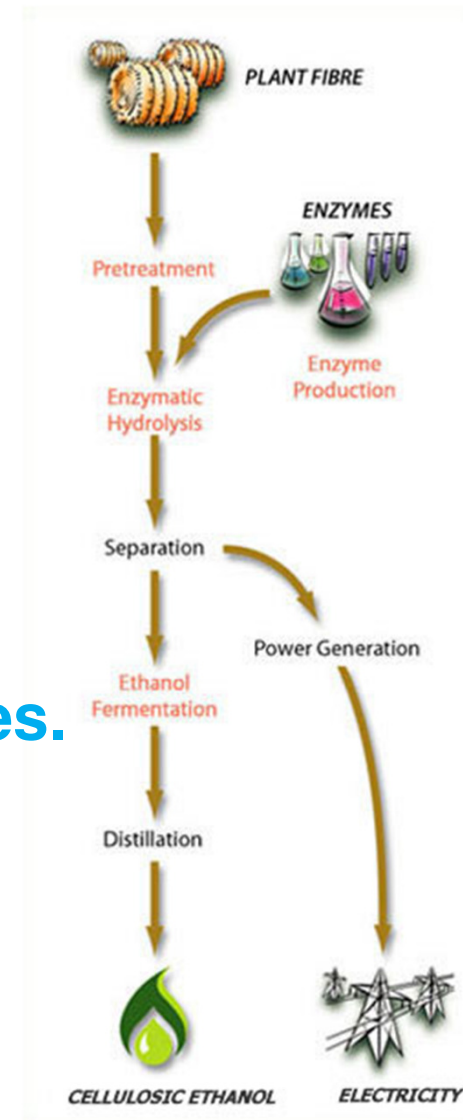

Separation Challenges

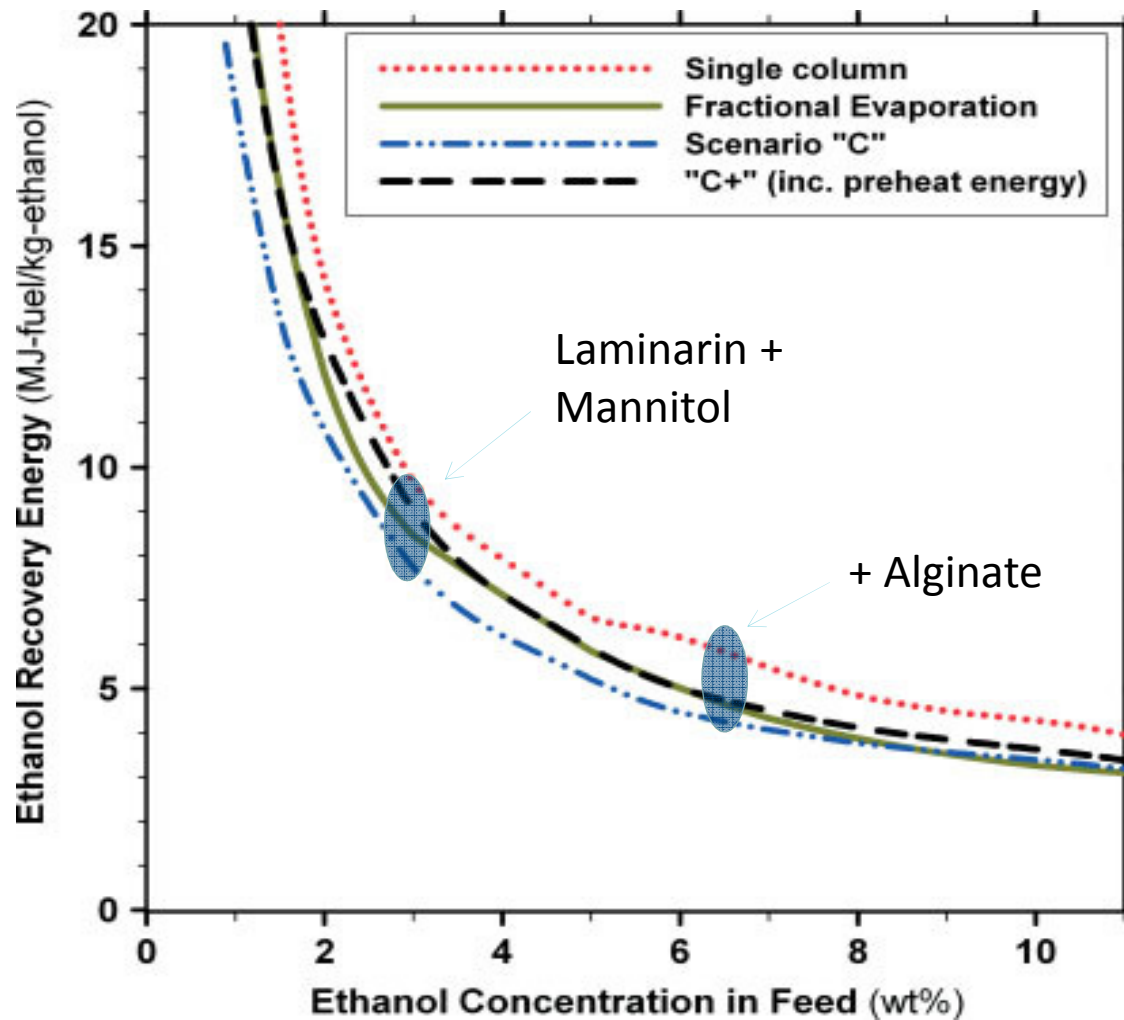

Recovery energy grows exponentially with dilution.

Figure from review article by Vane L, *Biofuels, Bioprod. Bioref.* 2:553–588 (2008)

Chemical Engineering

- Conceptual design

- Technology development based on basic insight, competence and process understanding.
 - Process Integration.
 - In-situ product removal.
 - Downstream processing.
 - Mass and Energy integration and optimization.
 - Process Intensification.
 - Reactor, membrane and separation technology.
 - CFD-modelling in high viscous systems.
- Technical and economical evaluation
 - Operational feasibility of process systems.
 - Estimation of investment, operating cost and profitability.

Chemical Engineering

- Upgrading and Separation

- Adsorption
- Distillation
- Liquid-liquid extraction
- Pervaporation
- Gas / Steam / Vapor Stripping
- Crystallization

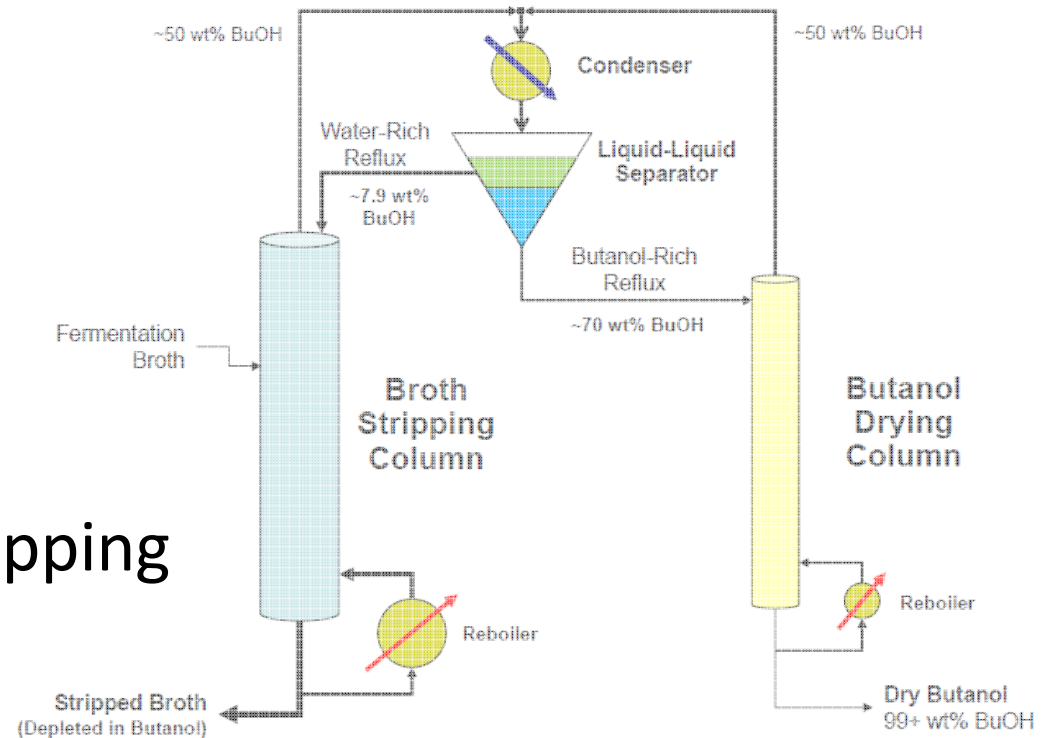

Example: Pervaporation

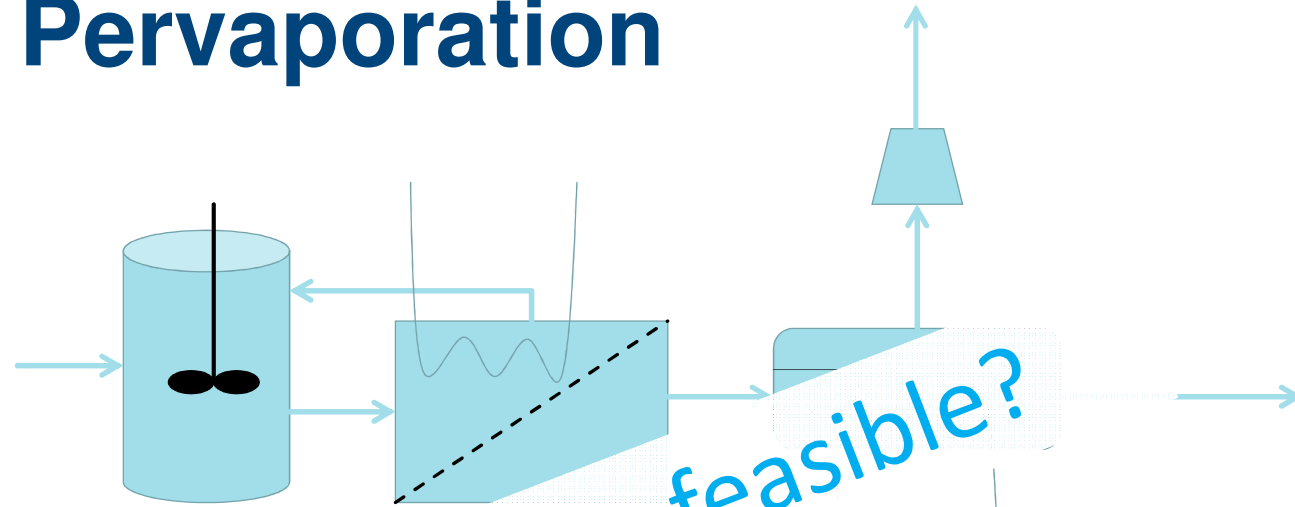

- Current ethanol selective membranes have low flux: 0.2 – 1.5 kg/m²h.
- Pressure permeate side must be low to generate driving force (\ll 50 kPa).
- Cooling medium of $< -15^\circ\text{C}$ requires refrigeration unit.

Example: Hybrid Separation

- Advanced vapor recompression schemes combined with membranes.
- Claims potential of 50% reduction in energy vs. distillation.
- Ongoing research.

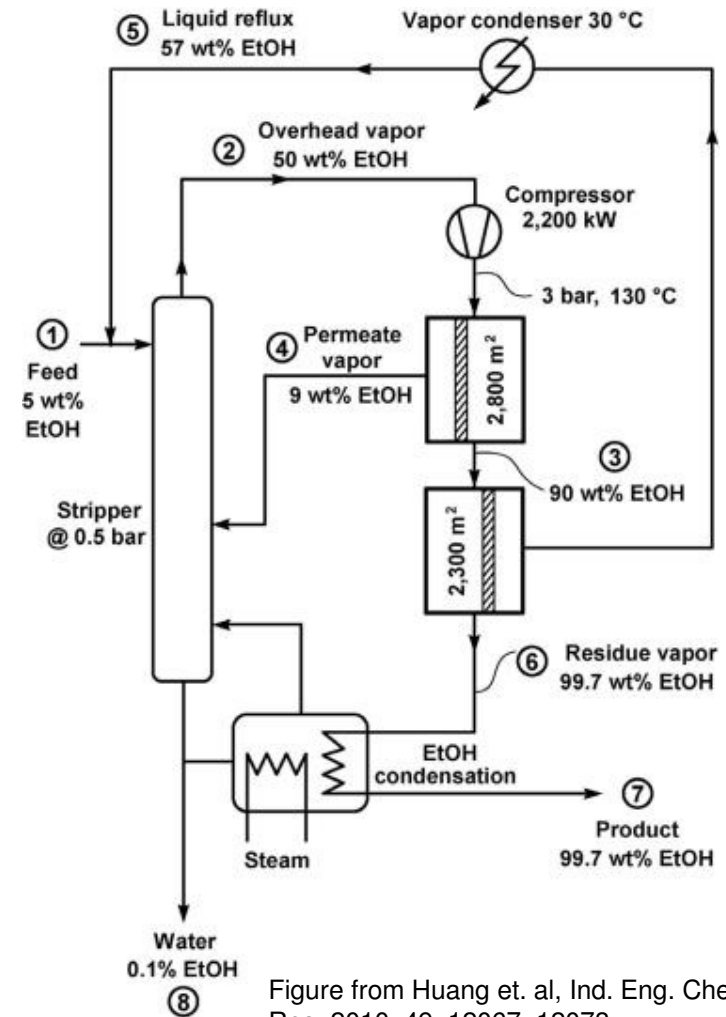

Figure from Huang et. al, Ind. Eng. Chem. Res. 2010, 49, 12067–12073

Current Research and Outlook

- Optimize yields in pretreatment and fermentation.
- Exploit byproducts (proteins, minerals).
- Alternative fermentation products.
 - Butanol, amino acids, omega-3 fatty acids.
- Hybrid separation – distillation with membranes.
- Reducing water content in the fermentation stage.
 - Extraction of sugars.
 - Hydrolysis with supercritical fluids.

Olaf Trygve Berglihn olaf.trygve.berglihn@sintef.no

Inga Marie Aasen inga.m.aasen@sintef.no

Bernd Wittgens bernd.wittgens@sintef.no



Technology for a better society