



Kelp-carbon uptake by Arctic deep-sea food webs plays a noticeable role in maintaining ecosystem structural and functional traits



Daniel Vilas^{a,b,c,*}, Marta Coll^{c,d}, Torstein Pedersen^e, Xavier Corrales^{c,f}, Karen Filbee-Dexter^{g,i}, Morten Foldager Pedersen^h, Kjell Magnus Norderhaugⁱ, Stein Fredriksen^j, Thomas Wernberg^{h,k}, Eva Ramírez-Llodra^g

^a Fisheries and Aquatic Sciences Program, School of Forest Resources and Conservation, University of Florida, Gainesville, FL 32611, United States

^b Nature Coast Biological Station, Institute of Food and Agricultural Sciences, University of Florida, Cedar Key, FL 32625, United States

^c Institut de Ciències del Mar (ICM-CSIC), P. Marítim de la Barceloneta, 37-49, 08003 Barcelona, Spain

^d Ecopath International Initiative (EII), Barcelona, Spain

^e Department of Arctic and Marine Biology, UiT–The Arctic University of Norway, 9037 Tromsø, Norway

^f AZTI Marine Research, Txatxarramendi Ugarte a z/g, E-48395 Sukarrieta, Spain

^g Norwegian Institute for Water Research (NIVA), Gaustadalléen 21, 0349 Oslo, Norway

^h Department of Science and Environment (DSE), Roskilde University, Roskilde, Denmark

ⁱ Institute of Marine Research, Nye Flødevigveien 20, 4817 His, Norway

^j University of Oslo, Department of Biosciences, PO Box 1066, Blindern, N-0316 Oslo, Norway

^k UWA Oceans Institute & School of Biological Sciences, University of Western Australia, Perth, WA, Australia

ARTICLE INFO

Keywords:

Kelp detritus
Particulate organic matter
Arctic ecosystem
Ecosystem structure
Mediation effect
Ecopath with Ecosim

ABSTRACT

The flow of non-living carbon (detritus) is considered an important process because it connects ecosystems and fuels benthic communities. In Norwegian kelp forests, 90% of the kelp production is exported to adjacent ecosystems where it can play a significant role in shaping benthic communities. We quantified the major structural and functional traits of an Arctic deep-sea ecosystem associated with kelp exports and assessed the ecological role of kelp export into the deep-sea system. We first developed a food-web model using the Ecopath with Ecosim (EwE) approach to represent the state of the deep (450 m) ecosystem of the Malangen fjord (Northern Norway) in 2017. Subsequently, we used the temporal dynamic model Ecosim to explore the structure and functioning traits of a theoretical deep-sea ecosystem projecting a decrease of kelp detritus biomass reaching the deep-sea ecosystem. Overall, our findings reveal that kelp detritus from shallow coastal areas has a small but noticeable role structuring the deep-sea ecosystem of Malangen. The temporal simulations show important differences depending on the application of mediating effects, which allow considering the detritus as a mediating group in prey-predator interaction, in addition to its direct role in trophic relationships. When mediating effects are applied, biomass increases for benthopelagic shrimps and suprabenthos groups and decreases for rays and skates, velvet belly, rabbitfish and other commercial demersal fishes under the low kelp detritus scenarios. Biomass-based and trophic-based indicators reveal a noticeable impact on the deep-sea ecosystem structure due to depletion of kelp detritus. To further assess future changes of the Arctic deep-sea ecosystems, dependencies with adjacent ecosystems, such as kelp detritus production, should be included.

1. Introduction

Non-living organic matter (Particulate Organic Matter, POM), also known as detritus (Moore et al., 2004), is an important source of food for marine benthic communities (Dunlop et al., 2016). This source of carbon may be produced in one ecosystem, and then transported and consumed in adjacent ecosystems (Cage, 2002). This flow of organic

carbon or connectivity between ecosystems has been widely documented (Filbee-Dexter et al., 2018; Krause-Jensen and Duarte, 2016). However, there is a lack of understanding on several aspects of this connectivity, such as the impact that detritus from one ecosystem has on the composition and structure of another ecosystem, and the different roles of alternative sources of organic carbon, such as detritus originated from phytoplankton and macrophyte (Renaud et al., 2015).

* Corresponding author at: Institut de Ciències del Mar (ICM-CSIC), P. Marítim de la Barceloneta, 37-49, 08003 Barcelona, Spain.

E-mail addresses: danielvilasgonzalez@gmail.com, dvilasgonzalez@ufl.edu (D. Vilas).

<https://doi.org/10.1016/j.jmarsys.2019.103268>

Received 11 July 2019; Received in revised form 13 November 2019; Accepted 19 November 2019

Available online 27 November 2019

0924-7963/ © 2019 Elsevier B.V. All rights reserved.

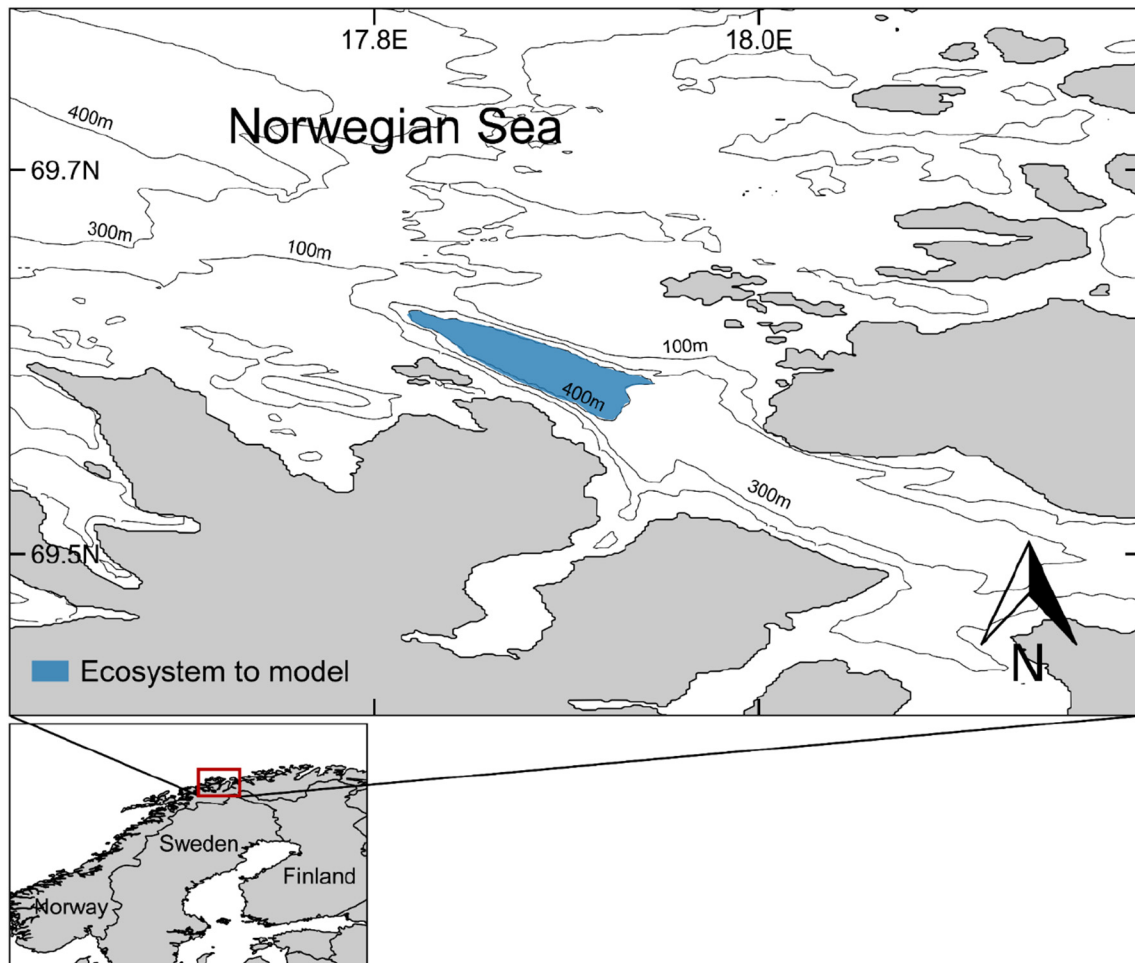

Fig. 1. Study area located in Malangen fjord, Northern Norway, and the Arctic deep ecosystem associated with kelp exports (ADEAKE) (blue polygon). (For interpretation of the references to colour in this figure legend, the reader is referred to the web version of this article.)

Moreover, human-induced alterations in material fluxes can have global consequences regarding carbon storage, nutrient translocation, environmental pollution and climate change (Masque et al., 2018).

Kelp-forest ecosystems produce the largest biogenic structures found in benthic marine ecosystems (Dayton, 1985), providing three-dimensional habitats along temperate and polar coastlines for a large number of marine species (Teagle et al., 2017; Wernberg et al., 2018). Kelp forests are a major source of primary production in coastal ecosystems (Mann, 2000) and support high secondary productivity of rich and diverse communities, maintaining high biodiversity and complex functions (Fredriksen, 2003; Norderhaug and Christie, 2011; Steneck et al., 2002). In Norway, extensive *Laminaria hyperborea* kelp forests dominate the rocky coasts with an average production of $600 \text{ g C m}^{-2} \text{ y}^{-1}$ (e.g. Pedersen et al., 2012), and exceptionally Abdullah and Fredriksen (2004) reported an average production of $2000 \text{ g C m}^{-2} \text{ y}^{-1}$. Major stress events, such as rising temperatures and population explosions of herbivorous sea urchins, have altered this productivity in some regions, resulting in major regime shifts from healthy kelp forest to sea urchin dominated barren grounds (Christie et al., 2019; Ling et al., 2015; Norderhaug and Christie, 2009). Many kelp forests have disappeared and have been replaced by turf algae over the last decade showing that while kelp forests may be increasing in some northern latitudes, many are declining in southern latitudes (Filbee-Dexter and Wernberg, 2018).

On a global perspective, about 80% of kelp production is exported from kelp ecosystems to shallow and deeper ecosystems (Krumhansl and Scheibling, 2012). This production of kelp detritus (POM) is

produced throughout the year from distal erosion, breakage, and mortality of the kelp, with shorter periods of high detrital production during peak cast of old laminas or dislodgement of whole plants (Filbee-Dexter et al., 2018). Although still poorly quantified, initial studies showed that macrophyte POM can play a significant role in shaping benthic communities, for example by providing connectivity among coastal habitats, which can influence spatial patterns (Vanderklift and Wernberg, 2008) and increase secondary productivity (Schaal et al., 2012). Similarly, the arrival of large pieces of macrophyte debris can provide a substantial food source to potentially food-limited deep-sea communities, affecting the local biodiversity and community structure (Bernardino et al., 2010; Ramirez-Llodra et al., 2016; Renaud et al., 2015; Vetter, 1995). A recent study performed on the Svalbard Archipelago demonstrated that kelp detritus from coastal communities can be an equally food resource for Arctic shelf communities down to 400 m depth, challenging the well-accepted paradigm of a tight benthopelagic coupling in coastal and continental shelf habitats in the Arctic (Renaud et al., 2015). In Norwegian kelp forests, it has been estimated that < 10% of the kelp production is consumed within the forest, and the rest is exported (Norderhaug and Christie, 2011). Although some studies highlighted the important role of macrophyte detritus fuelling adjacent communities (Filbee-Dexter et al., 2019), there is still a lack of understanding of the nature and extent of kelp contribution to these ecosystems, and no studies exploring this issue exist for the food web of deep benthic Arctic communities.

In this study, we quantified the major structural and functional traits of an Arctic deep-sea ecosystem associated with kelp exports and

assessed the ecological role of kelp export into the deep-sea system. First, we developed a food-web model using the Ecopath with Ecosim (EwE) approach (Christensen and Walters, 2004) to represent the state of the deep-sea ecosystem of the Malangen fjord (Arctic Norway) in 2017. Subsequently, we used the temporal dynamic model Ecosim (Christensen and Walters, 2004; Walters et al., 1997) to explore how reduced export of kelp detritus biomass could affect the Arctic deep-sea ecosystem under a scenario of kelp POM reduction.

To our knowledge, this is the first attempt to model a deep-sea (below 250 m depth) food web with a special emphasis on kelp detritus. Only a few previous studies have modelled ecosystems focused on kelp (Lozano-Montes et al., 2011; Pedersen et al., 2018), and other studies modelled kelp ecosystems without putting emphasis on kelp detritus (e.g. Nilsen et al., 2008a). These studies suggested that strong bottom-up effects would flow from changes in the biomass of benthic primary production by macrophytes to other levels of the ecosystem. Studies based on stable isotope analyses (Duggins et al., 1989; Fredriksen, 2003; McMeans et al., 2013; Renaud et al., 2015) highlighted the importance of kelp detritus as a source of carbon (but see Miller and Page, 2012). None of the studies that modelled fjord ecosystems in Norway (Pedersen et al., 2018, 2016, 2008) evaluated the importance of kelp secondary production to deep fjord food-webs.

2. Material and methods

2.1. Study area

The Malangen fjord, located 30 km southwest of Tromsø (69°30'N, 18°21'E) (Fig. 1), is 50 km long and about 5 km wide. We focused on the outer part of the fjord, which includes dense kelp forest as well as barren grounds, a few sandy beaches and a deep basin (~450 m maximum depth). The entrance of the Malangen fjord has extensive kelp forests down to 30 m depth. The dominant species is *Laminaria hyperborea*, which has a digitate annual blade produced during winter and spring and cast off the following spring (Kain, 1971). Parts of the old blades and other kelp fragments released by winter storms and grazing events reach the deep-sea ecosystem, and consequently, connect both ecosystems. The deep basin is connected to the open sea by a shallow sill (180 m deep), thus providing a potentially excellent accumulation site for kelp detritus from the surrounding coastal areas. We modelled the deep-sea ecosystem of Malangen fjord to represent the current situation at the time of the study (2017) (Fig. 2). We bounded the studied ecosystem from 400 to 450 m depth, covering an area of 11.8 km², and we included the entire water column. In this study, we call this ecosystem the Arctic Deep Ecosystem Associated with Kelp Exports (hereafter referred to as ADEAKE).

2.2. Modelling approach

The Ecopath and Ecosim approach (EwE) version 6.5 (Christensen et al., 2008; Christensen and Walters, 2004) was used to develop the food-web model of the ADEAKE in 2017. The Ecopath model provides a mass-balanced snapshot of the ecosystem. A functional group consists of ontogenic fractions of a species, individual species or groups of species that perform a similar function in the ecosystem, i.e. have similar growth rates, consumption rates, diets, habitats, and predators (Heymans et al., 2016). The parameterization in Ecopath is based on two master equations (Eqs. (1) and (2)), to which the mass-balance constrain is applied (Christensen et al., 2008; Christensen and Walters, 2004). The first master equation describes the energy balance for each group, so that:

$$\text{Consumption} = \text{production} + \text{respiration} + \text{unassimilated food} \quad (1)$$

The second Ecopath equation describes how the production term for each group (i) can be split into components. This is implemented with the equation:

Production

$$= \text{fishing mortality} + \text{predation mortality} + \text{biomass accumulation} \\ + \text{net migration} + \text{other mortality} \quad (2)$$

or, more formally,

$$P_i = Y_i + B_i M2_i + E_i + BA_i + P_i \cdot (1 - EE_i), \quad (3)$$

where P_i is the total production rate of i , Y_i is the total fishery catch rate of i , $M2_i$ is the total predation rate for group i , B_i the biomass of the group, E_i the net migration rate (emigration – immigration), BA_i is the biomass accumulation rate for i , while $MO_i = P_i \cdot (1 - EE_i)$ is the other natural mortality excluding predation (MO). MO is a catch-all term including all mortality not elsewhere included e.g. mortality due to disease or old age. In Ecopath, MO is not entered directly, as it is unknown, but is computed from the Ecotrophic Efficiency (EE). EE is the production of group i that is utilized within the system or is exported due to catches, migration or other causes (e.g. burial in sediments) (Christensen et al., 2008; Christensen and Walters, 2004). Eq. (3) can be re-expressed as follows:

$$(P/B)_i \cdot B_i = Y_i + \sum_j B_j \cdot (Q/B)_j \cdot DC_{ji} + E_i + BA_i + (P/B)_i \cdot B_i (1 - EE_i), \quad (4)$$

where P/B is the production to biomass ratio for a certain functional group i , $(Q/B)_j$ is the consumption to biomass ratio for each predator j , DC_{ji} is the proportion of group i in the diet of predator j , and $(1 - EE_i)$ represents mortality other than predation and fishing.

For each equation three of the four basic parameters (B_i , P/B_i , Q/B_i , EE_i) are required. Moreover, the catch by fleet and functional group (Y_j) and the diet (DC_{ij}) of all groups are also needed. The energy balance within each group is ensured when the consumption by group i equals the production by i , respiration by i and food that is unassimilated by i (Eq. (1)).

Afterwards, we used the temporal dynamic module Ecosim to simulate how the structural and functional traits of the ecosystem would change with a lower biomass input of kelp detritus (hereafter referred to as ADE – Arctic Deep Ecosystem model). Ecosim describes the temporal dynamics of species biomass and flows over time by accounting for changes in predation, consumption rate, fishing and the environment (Christensen and Walters, 2004; Walters et al., 1997).

Ecosim uses a set of differential equations to describe biomass dynamics, expressed as:

$$\frac{dB_i}{dt} = \left(\frac{P}{Q} \right)_i \cdot \sum Q_{ji} - \sum Q_{ji} + I_i - (M_i + F_i - e_i) \cdot B_i, \quad (5)$$

where dB_i/dt is the growth rate of group i during time t in terms of its biomass B_i ; $(P/Q)_i$ is the net growth efficiency of group i ; Q_{ji} is the consumption rate; M_i is the non-predation mortality rate; F_i is the fishing mortality rate; e_i is the emigration; and I_i is the immigration rate (Christensen and Walters, 2004).

Consumption rates (Q_{ji}) are calculated based on the “foraging arena” theory, which divides the biomass of prey into a vulnerable and a non-vulnerable fraction and the transfer rate or vulnerability between the two fractions determines the trophic flow between the predator and the prey (Ahrens et al., 2012). The vulnerability concept incorporates density-dependency processes and expresses how far a group is from its carrying capacity (Christensen et al., 2008; Christensen and Walters, 2004). Default values of vulnerability ($v = 2$) represents a mixed trophic flow, a low value ($v < 2$) indicates ‘bottom-up’ flow control and a situation closer to carrying capacity, while a high value ($v > 2$) indicates ‘top-down’ flow control and a situation further away from carrying capacity (Ahrens et al., 2012; Walters and Martell, 2004). EwE can also incorporate ecological mediation processes, when a predator–prey interaction between two functional groups is influenced by a third (mediating) group (Harvey, 2014). As demonstrated by Ma et al.

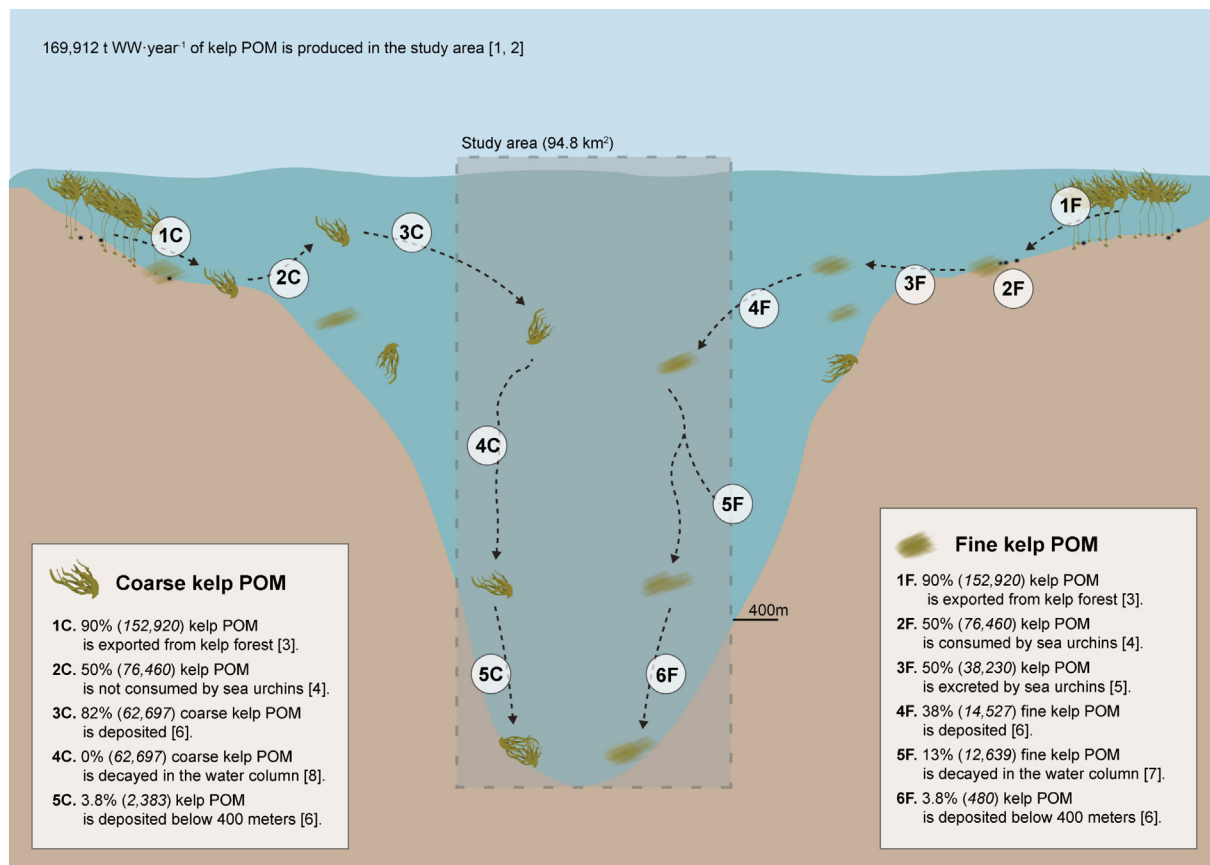

Fig. 2. Conceptual diagram of production and kelp detritus imports to the study area. Percentages are applied to previous step of kelp POM estimation, except for steps 1C and 1F which are applied to total kelp POM production in the study area (top left). The italic numbers in round brackets identify tons of wet weight per year ($t\ WW\text{-year}^{-1}$) of kelp POM. The numbers in square brackets identify the reference where information was extracted: [1] MF Pedersen et al in prep; [2] Bekkby et al., 2013; [3] Norderhaug and Christie, 2011; [4] Filbee-Dexter et al. in prep.; [5] Larson et al., 1980; [6] Rinde et al in prep.; [7] Sauchyn and Scheibling, 2009; [8] Filbee-Dexter et al in prep.

(2010), the mediating effect of a third (mediating) group on the predator–prey interaction of i and j can be introduced by adding a scaling term M_{ij} that affects the consumption rate of the predator. Further details on the algorithms, equations, and limitations of the EwE approach are described in the literature (e.g. Christensen and Walters, 2004; Heymans et al., 2016).

2.3. Parameterization of the ADEAKE model

To represent the ADEAKE food web, we defined the functional groups based on biological and ecological features of species such as diets, commercial value, data availability and expert knowledge. We adopted a similar composition of functional groups to other food-web models previously developed in Norwegian northern fjords (Pedersen et al., 2018, 2016, 2008) (Table 1 and Supplementary Material Table A.1 and A.2). The ADEAKE model was composed by 36 functional groups: one group of marine mammals, one of seabirds, 12 of fishes, 17 of invertebrates, one of primary producers, and four of detritus.

To evaluate the impact of kelp detritus in the ADEAKE, we included two kelp detritus functional groups considering their size (coarse kelp POM: $0.1\text{--}7.7\text{ mm}^2$; and fine kelp POM: $> 7.7\text{ mm}^2$) because these two types of kelp detritus differ in their export and uptake by the benthic community (Wernberg and Filbee-Dexter, 2018; Fig. 2). Coarse kelp POM is considered a source of food mainly for bacteria in the deep sea (Kelly, 2005), and needs to undergo decomposition (both abiotic and microbial breakdown) before the organic matter is available to most benthic fauna. Kelp POM rapidly hosts diverse communities of bacteria and protozoa on their surface, which increase its nutritional quality by

taking up inorganic nutrients from the surrounding water and accelerating degradation (Armstrong et al., 2000; Krumhansl and Scheibling, 2012). Benthic fauna that uses kelp, therefore often consume a mix of degraded kelp material and the microbial community that has colonized and associated with the material (Norderhaug et al., 2003). On the other hand, detritivore functional groups likely feed on fine kelp POM (Duggins and Eckman, 1997) in a similar way that they feed on other settling organic particles (Cage, 2002; Wotton and Malmqvist, 2001).

Some biological data used in this study were collected during a cruise within the KELPEX project (Kelp export: fuel for adjacent communities in changing arctic ecosystems, www.kelpex.org). The cruise on board R/V Johan Ruud was carried out on 26 April – 12 May 2017, and sampled the meio, macro and megafauna using multicores, grabs and trawls (see Ramirez-Llodra et al., submitted). All marine organisms were classified, and biomass was calculated for each species. Biomass was standardized to tones (t) wet weight by km^{-2} ($t\ \text{km}^{-2}$). Biomass of coarse kelp POM was calculated from kelp material collected with the trawls, while fine kelp POM biomass was calculated from small kelp particles on sediment collected with the grabs.

Biomass estimates for benthopelagic/pelagic species and bacteria were not available and therefore we either used realistic EE values to estimate the biomass of three functional groups (pelagic shrimps, benthopelagic shrimps, and bacteria) (Heymans et al., 2016), or we extracted the data from related models (Pedersen et al., 2016, 2008). Production (P/B , year^{-1}) and consumption (Q/B , year^{-1}) rates were either estimated using empirical equations (Heymans et al., 2016) or taken from literature or from other models and corrected for changes in

Table 1

Input parameters and outputs estimates (in bold) for the ADEAKE model showing those estimated by the model in bold. FG = Functional Group; TL = Trophic Level; B = Biomass ($t\text{-km}^{-2}$); P/B = Production/Biomass (year^{-1}); Q/B = Consumption/Biomass (year^{-1}); EE = Ecotrophic Efficiency (year^{-1}); P/Q = Production/Consumption (year^{-1}); U/Q = Unassimilated food/Consumption; FD = Flow to detritus ($t\text{-km}^{-2}$); Detritus import ($t\text{-km}^{-2}\text{years}^{-1}$); Landings and Discards ($t\text{-km}^{-2}\text{years}^{-1}$). Cells in grey represent values lower than 0.0001.

FG number	FG name	TL	B	P/B	Q/B	EE	P/Q	U/Q	FD	Detritus import	Landings	Discards
1	Marine mammals	4.65	0.02	0.07	14.10	0.00	0.00	0.20	0.05			
2	Seabirds	3.82	0.01	0.12	112.99	0.00	0.00	0.20	0.25			
3	Rays and skates	3.42	0.06	0.11	2.27	0.00	0.05	0.20	0.03			
4	Velvet belly	4.00	0.09	0.23	4.19	0.00	0.06	0.20	0.10			
5	Rabbitfish	3.46	1.22	0.12	4.80	0.01	0.03	0.20	1.32			0.0020
6	Greater argentine	3.29	0.17	0.34	4.59	0.49	0.07	0.20	0.19			
7	Blue whiting	3.36	0.76	0.61	4.86	0.07	0.13	0.20	1.18		0.0032	
8	Large fish feeders	4.18	0.09	0.06	1.62	0.47	0.04	0.20	0.03		0.0001	
9	Pouts	3.24	0.15	1.01	7.86	0.57	0.13	0.20	0.29			0.0004
10	Witch flounder	3.01	0.24	0.68	4.84	0.26	0.14	0.20	0.35			
11	Other commercial demersal fishes	3.72	0.23	0.18	3.15	0.90	0.06	0.20	0.15		0.0002	
12	Redfishes	3.56	0.12	0.19	3.95	0.11	0.05	0.20	0.12		0.0001	
13	Mesopelagic fishes	3.12	0.60	0.98	12.13	0.90	0.08	0.20	1.54			
14	Hagfish	2.18	0.02	0.30	6.40	0.46	0.05	0.20	0.03			
15	Benthopelagic cephalopods	3.39	0.01	1.68	12.77	0.74	0.13	0.20	0.02			
16	Pelagic shrimps	3.17	1.29	1.22	8.33	0.90	0.15	0.30	3.39			
17	Benthopelagic shrimps	2.90	0.50	1.50	10.00	0.90	0.15	0.30	1.59		0.0183	
18	Benthic detritivore echinoderms	2.18	0.28	0.23	3.63	0.80	0.06	0.40	0.42			
19	Detritivore polychaetes	2.16	13.13	1.51	10.07	0.30	0.15	0.40	66.70			
20	Other benthic detritivore invertebrates	2.22	0.45	0.55	2.88	0.97	0.19	0.40	0.53			
21	Predatory invertebrates	3.20	0.71	1.00	6.67	0.91	0.15	0.30	1.49		-	-
22	Sea cucumbers	2.17	4.82	0.23	2.88	0.04	0.08	0.40	6.61		-	-
23	Jellyfish and ctenophores	3.13	3.24	6.50	23.50	0.11	0.28	0.20	33.95		-	-
24	Large krill	2.39	10.62	1.25	16.80	0.50	0.07	0.30	60.11		-	-
25	Small krill	2.17	11.15	2.50	16.70	0.43	0.15	0.30	71.69		-	-
26	Macro and mesozooplankton	2.30	20.00	6.50	26.00	0.78	0.25	0.40	236.87		-	-
27	Microzooplankton	2.15	4.20	36.50	121.70	0.90	0.30	0.40	220.51		-	-
28	Suprabenthos	2.25	0.25	1.31	8.73	0.93	0.15	0.30	0.68		-	-
29	Meiofauna	2.25	1.14	10.64	42.56	0.64	0.25	0.30	19.00		-	-
30	Bacteria	2.00	1.80	143.00	340.50	0.90	0.42	0.20	148.63		-	-
31	Large phytoplankton	1.00	18.00	65.00	-	0.59	-	-	483.82		-	-
32	Heterotrophic nanofl.	2.90	1.64	36.50	121.67	0.95	0.30	0.20	43.10		-	-
33	Marine snow	1.00	122.30	-	-	0.56	-	-	460.71	0.66	-	-
34	Coarse kelp POM	1.00	1.05	-	-	0.78	-	-	4.55	25.13	-	-
35	Fine kelp POM	1.00	22.00	-	-	0.55	-	-	3.46	5.07	-	-
36	Benthic detritus	1.00	67.00	-	-	0.80	-	-	-	-	-	-

water temperature between study areas following Opitz (1996) (Supplementary Material Table A.1).

Quantitative diet information was compiled using published data and records from the KELPEX field survey on stomach content analyses, giving preference to data collected from local or similar areas. Regarding kelp detritus feeders, diet information was obtained from observations in the study area (Filbee-Dexter unpublished data) and literature (Dunton and Schell, 1987; Fredriksen, 2003; Renaud et al., 2015) and was revised by local experts. These previous studies quantified the proportion of kelp detritus in the diet of different detritivores and highlighted some species that were more reliant on kelp detritus than phytodetritus. When diet information was available for generalists deposit feeders, we set a diet based on the proportion of kelp detritus in detritus biomass stock. For migratory species (marine mammals, seabirds and benthopelagic cephalopods), we set a fraction of the diet composition as import based on the time that these species feed outside the system (Christensen et al., 2008; Heymans et al., 2016) (Supplementary Material Table A.2).

Fisheries data were obtained from the Institute of Marine Research and the Norwegian Directorate of Fisheries (Fiskeridirektoratet, 2017; NMDC, 2017). Fisheries data were geolocated, and all data inside the ADEAKE boundaries were considered. We split the fishery into two commercial fishing fleets: shrimp trawlers, and gillnetters and others.

An important point in the development of the model was the parameterization of the imported biomass of kelp POM in the deep-sea ecosystem. The kelp POM that is reaching the deep fjord is transported as settling particles. Among these detritus particles, faecal pellets (fine kelp POM) and marine snow are particularly important, and benthic communities respond differently depending on the form of that organic

material (Gooday and Turley, 1990). Because of this difference, we estimated imported kelp POM biomass into our study area separately for both kelp POM groups. To properly incorporate this into the model, we used a combination of literature values, our own knowledge, and field results (Fig. 2). We first extracted the area covered by kelp forests in our study area and the per-area production of kelp POM (Bekky et al., 2013; M.F. Pedersen et al. in prep.). We then estimated the proportion of that annual production that enters the deep-sea ecosystem, taking into account processes that influenced its export and landing on the deep-basis (shallow consumption and excretion by sea urchins, transport processes in the water column before deposition, decomposition, and buried processes). Kelp POM production processes were represented in order to understand those processes and production estimations (Fig. 2). To allocate the detritus fate from the living groups to each detritus group defined in our model (marine snow, coarse kelp POM, fine kelp POM, and benthic detritus), we used the detritus fate parameter, which allowed us to specify where the remaining detritus left over after detritivores have met their food intake is to be directed. In our case, information by local deep-sea ecologists and kelp ecologists, and literature was used (Fig. 3). Surplus marine snow was directed to benthic detritus group. Regarding kelp POM groups, the excess of coarse kelp POM was either routed to fine pieces of POM through fragmentation (83%) or buried (17%). The first flow represented erosion process in coarse kelp POM (scaled from fragmentation rates of old blade inputs between May and August estimated using size of kelp detritus at 400 m depth in the study area, (Filbee-Dexter et al., 2018), the second represented burial process already described in previous studies (Carroll et al., 2008; Zaborska et al., 2018). Unconsumed fine kelp POM was exported out of the system (20%) or

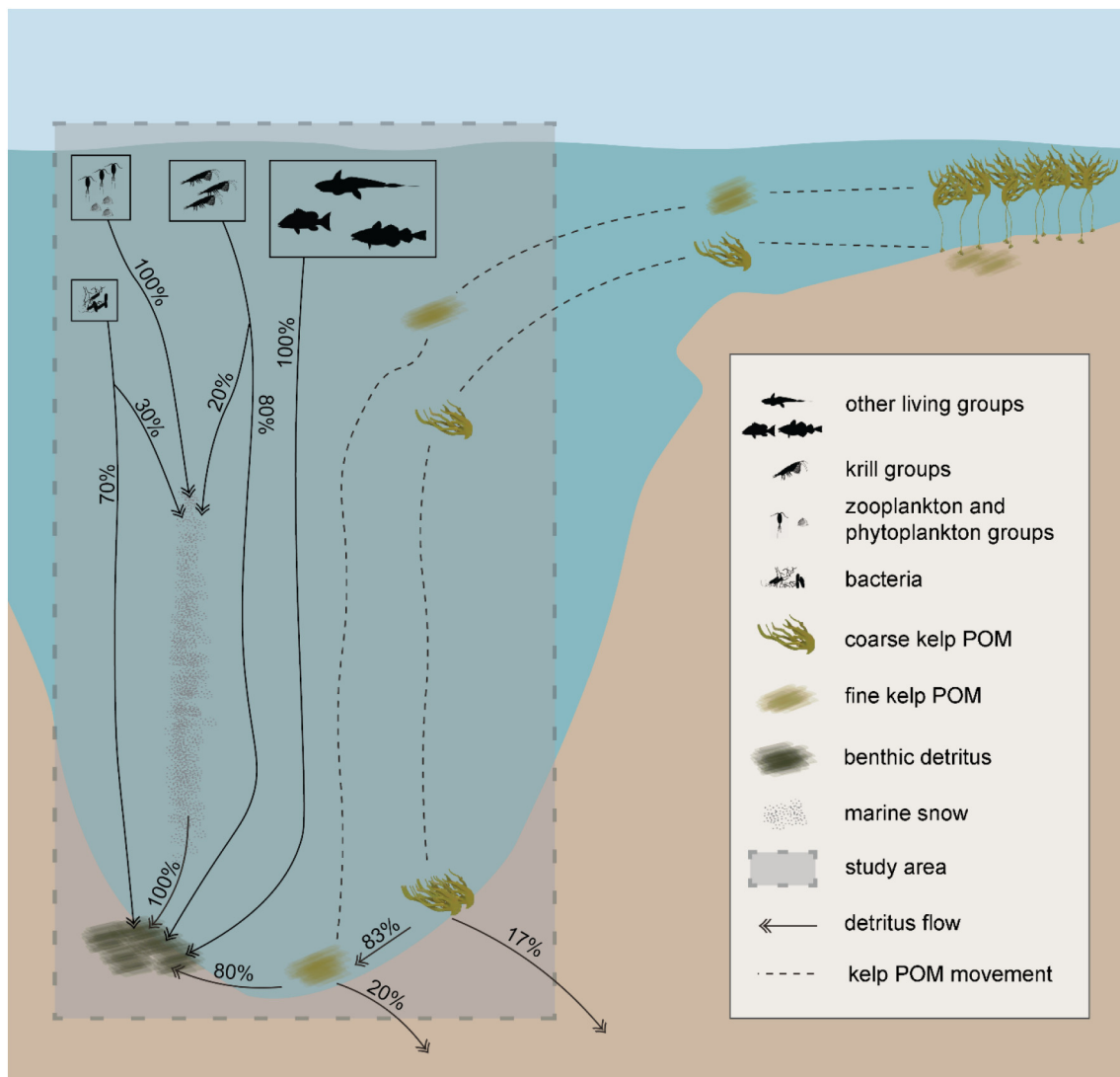

Fig. 3. Conceptual diagram of detritus fate parameter describing the process of detritus leftovers and its pathway.

directed to benthic detritus (80%), which acted as a general benthic detritus pool in the ADEAKE model.

2.4. Ensuring mass-balance and assessing the quality of the model

In order to ensure that the model followed general ecological and biological principles and to guide the balancing procedure, we used the PREBAL diagnostics (Link, 2010). An Ecopath model is considered ecologically and thermodynamically balanced when: (1) $EE < 1.0$; (2) P/Q values are between 0.05 and 0.35 with the exception of fast-growing groups such as bacteria; (3) R/A (respiration/food assimilation) < 1 ; (4) R/B (respiration/biomass) range from 1 to 10 for fishes and higher values for small organisms; (5) NE (net efficiency of food conversion) $> GE (=P/Q)$ and (6) P/R (production/respiration) < 1 (Supplementary Material Table A.4) (Christensen et al., 2008; Heymans et al., 2016). Initial values of the ADEAKE model showed that the $EE > 1$ for 6 functional groups (mesopelagic fishes, benthopelagic cephalopods, benthic detritivore echinoderms, other benthic detritivore invertebrates, large krill, and suprabenthos). To balance the ADEAKE model, we applied a manual mass-balanced procedure following a top-down approach modifying input parameters starting from the functional groups with higher TL and considering the best practice guidelines (Heymans et al., 2016).

The quality of the model was estimated by calculating its pedigree, a

summary of the quality of input parameters used to parameterize the model for which each input is associated to a confidence interval (Christensen et al., 2008; Christensen and Walters, 2004). This information was first used to determine which parameters were of lower quality and thus could be modified during the balancing procedure. Afterwards, it was used to calculate the pedigree index of the overall model, which vary between 0 (lowest quality) and 1 (highest quality) (Christensen and Walters, 2004). The confidence intervals and index values used to describe the uncertainty of the balanced Ecopath model are described in the Supplementary Material (Table A.5).

Stable isotopes of Nitrogen ($^{15}\text{N}/^{14}\text{N}$) can serve as independent measures of the trophic position of organisms (Peterson and Fry, 1987). Nitrogen stable isotope ($^{15}\text{N}/^{14}\text{N}$) values available in the literature coming from adjacent ecosystems to the ADEAKE were compiled (Chouvelon et al., 2012; Fuhrmann et al., 2017; Hooker et al., 2001; Jennings et al., 2002; Nilsen et al., 2006, 2008b; Petursdottir et al., 2012) (Supplementary Material Table A.6). This information was compared with the ADEAKE model-estimated Trophic Levels (TL) of functional groups, and the correlation was tested using the Spearman-rank non-parametric correlation coefficient test. Previous studies used this methodology to validate Ecopath model results (Corrales et al., 2017; Deehr et al., 2014; Navarro et al., 2011).

2.5. Model analyses and ecological indicators

Flows and biomasses were aggregated into discrete TLs to calculate the Lindeman spine breakdown plot (Lindeman, 1942). This analysis also includes the Transfer Efficiency (TE), the fraction of total flows of each discrete level that are either exported out of the ecosystem (e.g. by fishing) or transferred to higher trophic levels through consumption (Lalli and Parsons, 1997; Pauly and Christensen, 1995).

We computed the following ecological indicators that describe the state of the ecosystem: Total System Throughput (TST, $t\text{-km}^{-2}\text{-year}^{-1}$), the sum of all flows in the model (consumption, export, respiration and flow to detritus) and considered an overall measure of the “ecological size” of the system (Finn and Finn and Finn, 1976), Finn's Cycling Index (FCI, %), the fraction of the ecosystem's throughput that is recycled (Finn and Finn and Finn, 1976), System Omnivory Index (SOI), the average of omnivory index of all consumers weighted by the logarithm of each consumer's food intake, and Connectance Index (CI), the number of actual links in relation to the number of possible links in the food-web (Gardner and Ashby, 1970). Several additional indicators were selected because of their robustness in front of models comparison (Heymans et al., 2016): the ratios of consumption (Q), export (Ex), respiration (R) and flow to detritus (FD), the total biomass of the community (TBCo), relative ascendancy (A/C) and relative overhead (O/C) (for definitions see Heymans, 2014).

Some of these ecological indicators obtained from the ADEAKE model were compared with those from the Ullsfjord model (Pedersen et al., 2016), although some of them could not be compared because the Ullsfjord model used different units ($g\ C\text{-km}^{-2}$). This model was selected as it was developed following similar criteria of the ADEAKE model to define functional groups and to estimate input data. Ullsfjord is a fjord located in Northern Norway, as is the case of the Malangen fjord.

To quantify direct and indirect trophic interactions among functional groups, we used the Mixed Trophic Impact (MTI) (Ulanowicz and Puccia, 1990) (Eq. (6)). This analysis quantifies the direct and indirect impacts that a hypothetical increase in the biomass of one functional group would have on the biomasses of all the other functional groups, including the fishing fleets. The MTI for living groups is calculated by constructing an $n \times n$ matrix, and quantifying each interaction between the impacting group (j) and the impacted group (i) is:

$$MTI_{ji} = DC_{ji} - FC_{ij}, \quad (6)$$

where DC_{ji} is the diet composition term expressing how much i contributes to the diet of j , and FC_{ij} is a host composition term giving the proportion of the predation on j that is due to i as a predator. The MTI can be used as a sensitivity analysis to explore possible impacts of biomass variations. Therefore, relative total impact (RTI) (Eq. (7)) can be calculated from the MTI as an overall effect of group i on all the other groups in the food-web (without including the effect on the group itself):

$$RTI = \sqrt{\sum_{j \neq i}^n MTI_{ij}^2} \quad (7)$$

To identify the keystone species within the ecosystem, we estimated the keystone index (KS) using Valls et al. (2015) method (Eq. (8)), in which the biomass component is based on a descending ranking. A keystone species is a species that shows relatively low biomass but has a relatively important role in the ecosystem (Power et al., 1996). Valls keystone index is calculated as:

$$KS_i = \log[IC_i \cdot BC_i] \quad (8)$$

where IC_i is a component estimating the trophic impact of the group i ; BC_i is a component estimating the biomass of the group i .

To assess the role and impact of fishing, we used several ecological indicators. The MTI analysis was used to quantify the direct and

indirect impact of each fleet on the functional groups. We included Total Catches (TC, $t\text{-km}^{-2}\text{-year}^{-1}$), the total landings and discards exported from the system; mean TL of the catch (mTLc), the average trophic level of all caught species weighted by their yield (Pauly et al., 1998); and the Primary Production Required to sustain the catches per unit of Primary Production (PPR/totPP) (Christensen et al., 2008).

2.6. Impact and role of kelp detritus

To specifically evaluate the impact and role of kelp detritus, we analysed those relevant results obtained from the ADEAKE model to assess the importance of kelp detritus in the current configuration of the ecosystem. We used the Lindeman spine (Lindeman, 1942) to represent the flows of the food-web aggregated into integer trophic levels, and separated detritus groups to allow the quantification of the flow to benthic detritus, % TST, consumption, and predation, specifically for both kelp detritus functional group. The MTI analysis was used to quantify the impact on kelp detritus and identify the impacted and impacting functional groups.

Additionally, we used the temporal dynamic module Ecosim (Christensen and Walters, 2004; Walters et al., 1997) to study the hypothetical effects of decreasing kelp POM biomass inputs on the deep-sea food web. In Ecosim, standing biomasses of both kelp detritus groups were forced to decrease 10% annually, while fishing effort was kept constant in order to focus on changes in the food web due to kelp detritus reductions only. During the temporal dynamic simulations, we increased kelp POM vulnerability ($v = 100$) to allow a notable increase in consumption on detritus if the biomass of consumers increases. Subsequently, two scenarios were simulated including or not the role of kelp detritus as a mediating group in prey-predator interaction, in addition from its direct role in trophic relationships. Both scenarios (with mediation and without) were tested in order to evaluate the impact of mediating effects in the food web since kelp detritus mediating functions are not well-studied. The scenario with mediating relationships included two mediating functions (M1 and M2) linked to chosen prey-predator interactions mediated by coarse kelp POM, which were previously described in the literature (Ramirez-Llodra et al., 2016; Shaffer et al., 1995) (Supplementary Material Fig. B.1). Because there were non-specific quantitative studies describing these prey-predator interactions, we established the mediation functions as well as initial mediation state based on literature information. The first mediation function (M1) used a positive sigmoid function, and it simulated an increase in prey vulnerability when coarse kelp POM biomass was high. M1 was used for benthopelagic shrimps – predator and suprabenthos – predator interactions because these preys are attracted by coarse kelp POM (Ramirez-Llodra et al., 2016) and may concentrate and be available for their predators when coarse kelp POM is abundant (Supplementary Material Fig. B.2). This non-trophic relationship between kelp and fish predators has been documented in previous studies (Pérez-Matus and Shima, 2010), where fish predation reduced grazing pressure of amphipods on kelp. Inversely, the second mediating effect (M2) used a negative sigmoid function to capture a decrease in prey vulnerability when coarse kelp POM biomass was high. M2 was used for “other commercial demersal fishes” group – predators and redfishes – predators interactions because juveniles of these species use drifting kelp to protect themselves against predation (Shaffer et al., 1995). After 20 years of decreasing kelp POM biomass of the ADEAKE model using the temporal simulations, we reached two new hypothetical ecosystem states with low biomass of kelp detritus, which we called them mediated ADE (Arctic Deep-Ecosystem including M1 and M2 mediated functions during the temporal dynamic simulations) and non-mediated ADE (Arctic Deep-Ecosystem without including any mediated functions during the simulations).

Keystone index and several ecological indicators (Cury and Christensen, 2005; Heymans et al., 2014) (mentioned above) were obtained for both ADE models and were compared with the ADEAKE

model in order to describe important structural and functional traits of the ecosystem and to quantify the ecological role of kelp detritus. Additionally, we described the ecosystem using a plug-in to derive standardized ecological indicators (ECOIND) (Coll and Steenbeek, 2017) related with species traits (biomass, catch, trophic, size and species-based). We focused on biomass-based indicators and trophic-based indicators. Biomass-based indicators are based on the abundance of organisms in the food-web (Coll and Steenbeek, 2017), and we selected: biomass of commercial species, biomass of invertebrates species, biomass of fish species and the Kempton's diversity index. Next, we chose trophic-based indicators because of their capability to capture possible alterations on the trophic structure of the ecosystem caused by impacts (e.g. fishing) (Shannon et al., 2014). We selected five indicators based on the trophic level (TL): TL of the catch, TL of the community, TL of the community including organisms with $TL \geq 2$, TL of the community including organisms with $TL \geq 3.25$ and TL of the community including organisms with $TL \geq 4$.

To consider the uncertainty associated with the temporal simulation, we run 500 Monte Carlo simulations. We used the pedigree information with associated confidence intervals for the input values in the Monte Carlo routine in Ecosim (Heymans et al., 2016). For each run, input values of the Ecopath models were randomly sampled from uniform distributions, with the width of distributions corresponding to the pedigree-specified input uncertainty level. The 95% and 5% percentile confidence intervals (CIs) were calculated for selected functional groups biomasses and ecological indicators previously mentioned.

3. Results

3.1. Ecosystem structure and functioning of the ADEAKE ecosystem

Results showed strong interactions between low TL groups (such as detritivore polychaetes) and detritus groups (Fig. 4a). In line with that, most of the energy flows in the study area occurred between TL I (primary producers, kelp POM, and benthic detritus) and TL II, which collectively represented approximately 90% of the TST (Fig. 5). Also, TL 2 produced the highest flows to detritus of the ecosystem ($725 \text{ t km}^{-2} \text{ year}^{-1}$). The transfer efficiency of the system was 18.41%, and it decreased with trophic level.

The highest contributions in terms of flows to benthic detritus

corresponded to large phytoplankton, marine snow, macro and mesozooplankton, and microzooplankton groups (Table 1). The flow to detritus accounted for 33.31% of the flows of the ADEAKE ecosystem, almost half (45.17%) were consumed, 2.92% was exported, and 18.61% was respired (Table 2). These percentages of flows through the ecosystem showed some differences to the Ullsfjord model. Specifically, the ADEAKE model showed higher percentages on flows to detritus and export flows over TST, and lower percentages on consumption and respiration flow over TST than Ullsfjord model.

Regarding ecological indicators, while SOI and CI were higher for the ADEAKE than Ullsfjord model (increasing 1.80%, 27.78% and 17.65% respectively), FCI, A/C and O/C showed similar values between both models (Table 2).

3.2. Ecological role of functional groups

TLs values ranged from 1 for primary producers and detritus groups to 4.65 for marine mammals' group (Table 1 and Fig. 4a). TLs were positively correlated with the ^{15}N values from adjacent ecosystems (Fig. 4b, Spearman-rank correlation coefficient, $r_s = 0.65$, $n = 20$, $p < 0.0001$). These results showed that an increase of ^{15}N values calculated from SIA coincided with an increase of TLs estimated by the ADEAKE model.

The Ecotrophic Efficiency (EE) values per functional group were moderate for several functional groups (Table 1), indicating that these groups are not fully consumed in the ecosystem or taken by the fishery (Heymans et al., 2016). High values of EE (> 0.90) were estimated for several benthic invertebrates' groups (other benthic detritivore invertebrates, predatory invertebrates, and suprabenthos), planktonic groups (microzooplankton, large phytoplankton, and heterotrophic nanoflagellates) and detritus groups (coarse and fine kelp POM). Low values of EE (< 0.10) were obtained for top predators' groups such as marine mammals and seabirds, and for blue whiting, jellyfish and ctenophores and sea cucumber group.

The most impacting (positively and negatively) living group in the ADEAKE system was benthopelagic shrimp (Fig. 6). Specifically, it impacted negatively on rays and skates, velvet belly and rabbitfish group due to multiple indirect trophic relationships, and positively on shrimp trawlers due to it would promote an increase of their catches.

Marine mammals, seabirds, rabbitfish, large fish feeders and

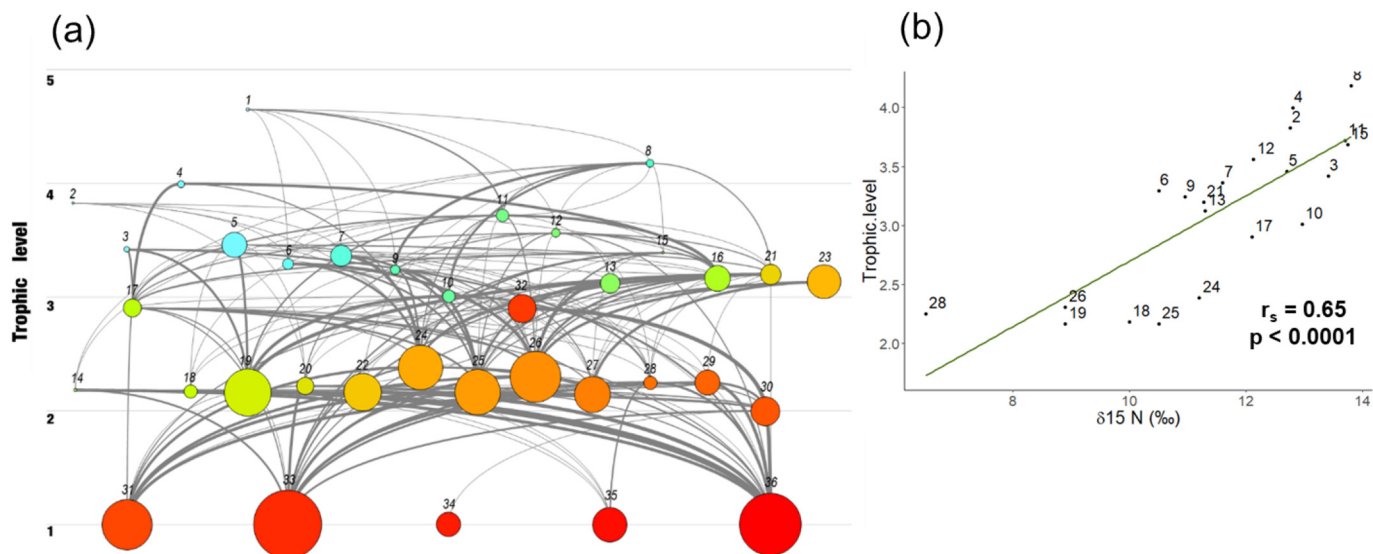

Fig. 4. (a) Flow diagram of the ADEAKE model. The size of each circle is proportional to the biomass of the functional group. The numbers identify the functional groups of the ADEAKE model (Table 1). The wideness of the connecting lines is proportional to the magnitude of their flows. (b) Correlation between trophic level (TL) calculated with the 2017 Ecopath model and the ^{15}N values calculated from stable isotope analysis of adjacent ecosystems. The numbers in the figure identify the functional groups of the model (listed in Table 1). P -value come from Spearman's rank correlation test.

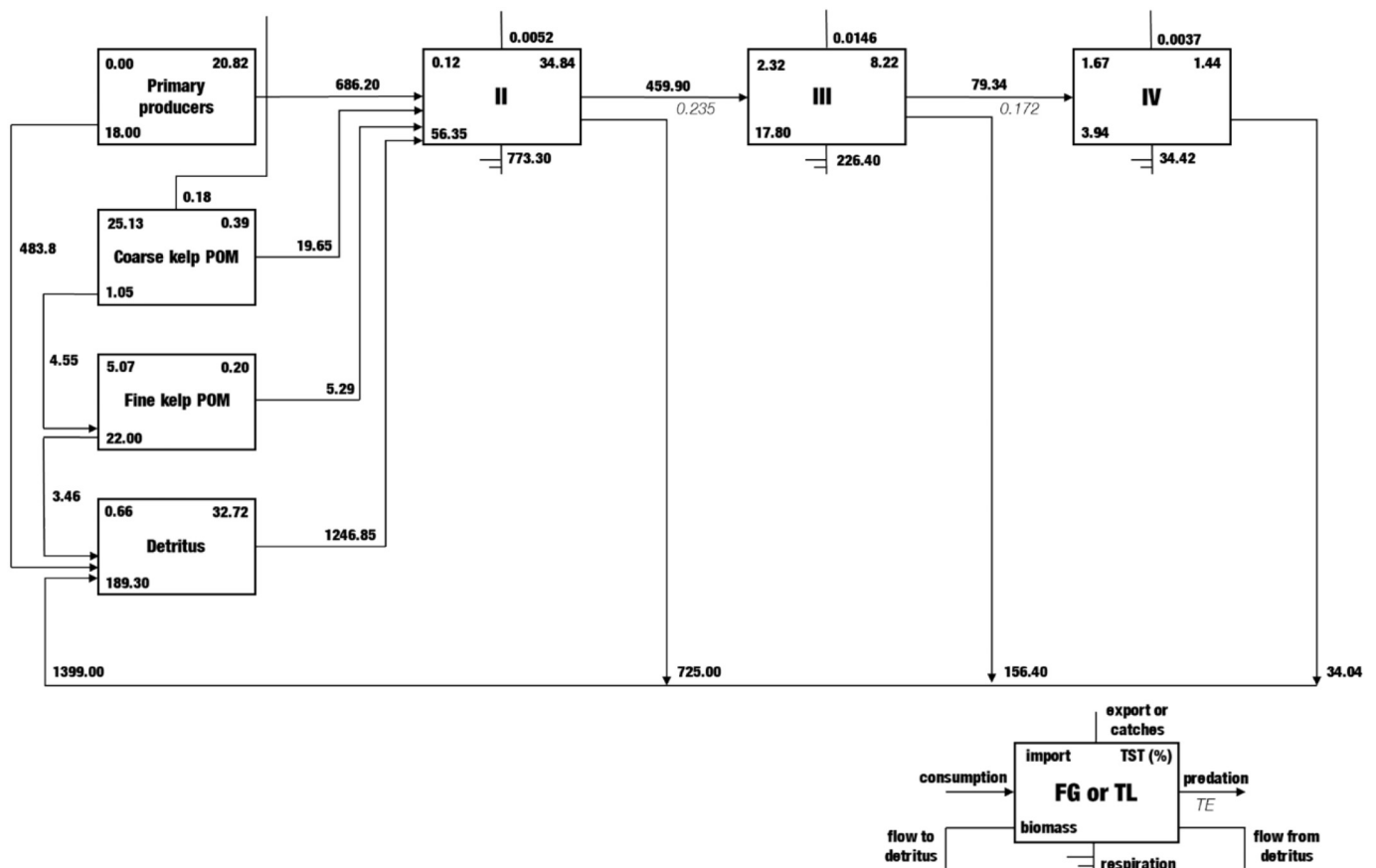

Fig. 5. Trophic flows of the ADEAKE model organized by integer trophic levels (TL) in the form of Lindeman spine. TL I is split into primary producers, coarse kelp POM, fine kelp POM, and detritus. Flows are represented in $t \cdot km^{-2} \cdot year^{-1}$.

Table 2

Statistics and ecological indicators for the Arctic Deep Ecosystem Associated to Kelp Exports for 2017(ADEAKE), Ullsfjord (northern Norway) for 1993–1996 (Pedersen et al., 2016), the non-mediated Arctic Deep Ecosystem for 2037 (non-mediated ADE), and the mediated Arctic Deep Ecosystem for 2037 (mediated ADE).

Acronym	Ecological indicator	Units	Ecopath models				% of change		
			ADEAKE (2017)	Ullsfjord (1993–1996)	Non-mediated ADE (2037)	Mediated ADE (2037)	Ullsfjord vs ADEAKE	ADEAKE vs non-mediated ADE	ADEAKE vs mediated ADE
Q	Sum of all consumption	$t \cdot km^{-2} \cdot year^{-1}$	2528.48	–	2493.28	2504.71	–	–1.39	–0.94
Ex	Sum of all exports	$t \cdot km^{-2} \cdot year^{-1}$	163.25	–	179.86	179.09	–	10.17	9.70
R	Sum of all respiratory flows	$t \cdot km^{-2} \cdot year^{-1}$	1041.61	–	1026.47	1028.62	–	–1.45	–1.25
FD	Sum of all flows into detritus	$t \cdot km^{-2} \cdot year^{-1}$	1904.31	–	1899.21	1919.08	–	0.27	0.78
TST	Total system throughput	$t \cdot km^{-2} \cdot year^{-1}$	5638.32	–	5598.82	5631.50	–	–0.70	–0.12
PP/TST	Primary production/TST	%	20.75	25.73	20.92	20.82	–19.35	0.82	0.36
Q/TST	Total consumption/TST	%	44.85	56.14	44.53	44.48	–20.11	–0.71	–0.83
Ex/TST	Total exports/TST	%	2.91	0.00	3.21	3.18	–	10.31	9.28
R/TST	Total respiration/TST	%	18.47	25.73	18.33	18.27	–28.22	–0.76	–1.11
FD/TST	Total flow detritus/TST	%	33.77	18.13	33.92	34.08	86.27	0.44	0.91
FCI	Finn Cycle Index	%	15.27	15.00	14.99	15.15	1.80	–1.83	–0.79
SOI	System Omnivory Index	–	0.23	0.18	0.23	0.23	27.78	0.00	0.00
CI	Connectance Index	–	0.20	0.17	0.20	0.20	17.65	0.00	0.00
TBCo	Total biomass community	$t \cdot km^{-2} \cdot year^{-1}$	97.01	–	95.56	96.46	–	–1.49	–0.57
A/C	Ascendancy/capacity	%	26.10	26.60	26.18	26.23	–1.88	0.31	0.50
O/C	Overhead/capacity	%	73.90	73.40	73.82	73.77	0.68	–0.11	–0.18
TC	Total catch	$t \cdot km^{-2} \cdot year^{-1}$	0.02	–	0.02	0.04	–	0.00	100.00
mTLC	Mean trophic level of the catch	–	3.03	3.87	3.03	2.94	–21.71	0.00	–3.30
PPR/totPP	Primary production required to sustain catch per total PP	%	0.44	–	0.44	0.47	–	0.00	6.82
FD	Flow to detritus	$t \cdot km^{-2} \cdot year^{-1}$	829.7	–	832.00	833.10	–	0.28	0.46

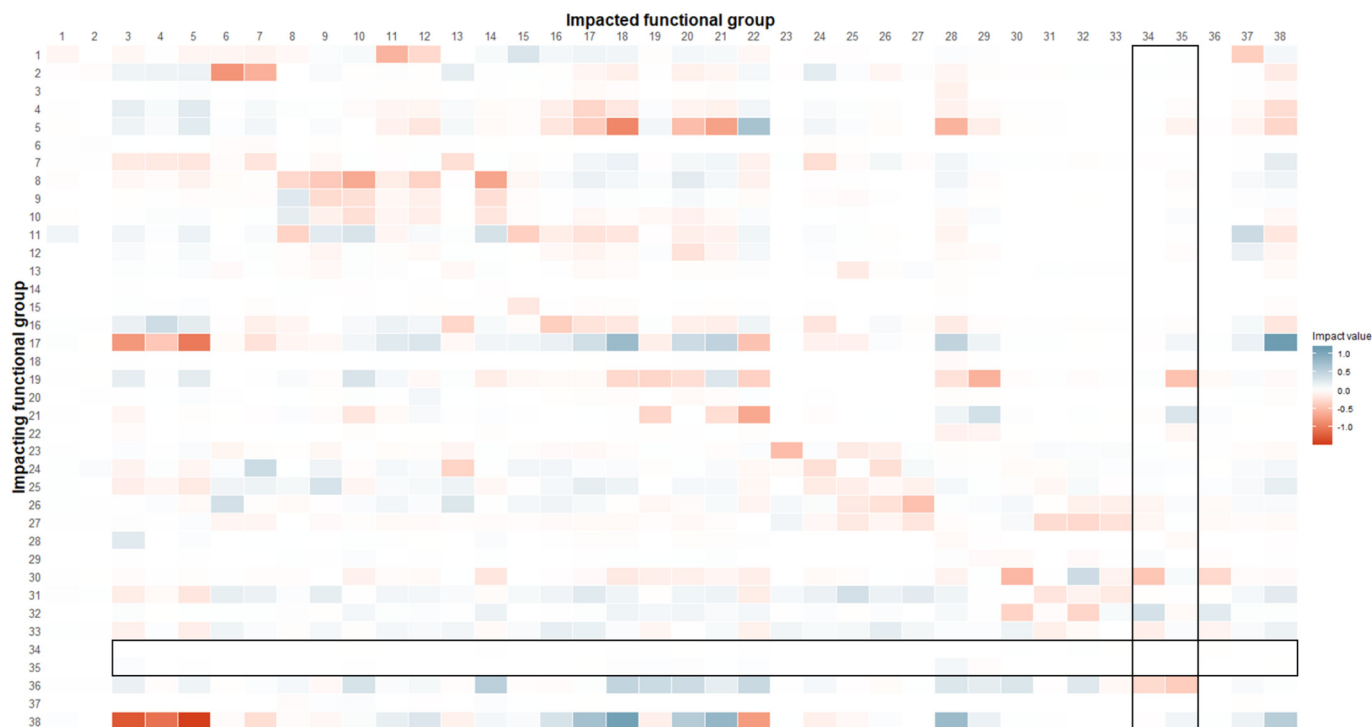

Fig. 6. Mixed Trophic Impact (MTI) analysis of the ADEAKE model. Negative (red) and positive (blue) impacts are represented. The numbers in the figure identify the functional groups of the model (listed in Table 1), except for numbers 37 and 38, which represent the fishing fleets (Gillnetters and others, and Shrimp trawlers, respectively). Highlighted groups represent kelp POM groups (34 and 35). (For interpretation of the references to colour in this figure legend, the reader is referred to the web version of this article.)

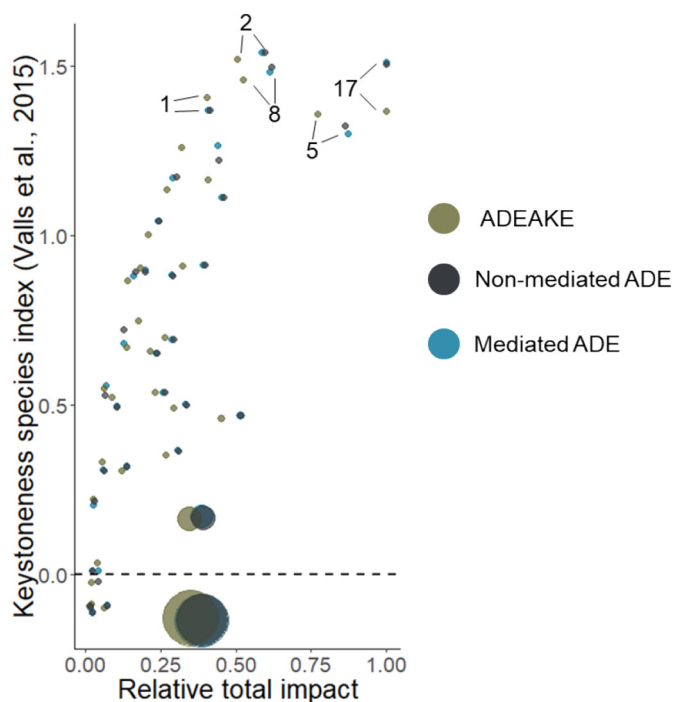

Fig. 7. Keystone Index analysis of the ADEAKE (2017), non-mediated ADE (2037) and mediated ADE model (2037). The size of each circle is proportional to the biomass of the functional groups. The numbers identify the functional group of the model (listed in Table 1) with higher keystone index and relative total impact.

benthopelagic shrimps were identified as keystone functional groups (Fig. 7). These results confirmed that these functional groups play an important ecological role in the ecosystem despite they have relatively low biomass. Among these functional groups, benthopelagic shrimps had the highest combined value of keystone index and RTI (, in line with the MTI results (Fig. 6).

3.3. Ecological role of kelp detritus

Kelp detritus (coarse and fine kelp POM) flowing into the ADEAKE accounted for 0.59% of the TST (Fig. 5). The flow to detritus was low for both kelp detritus groups: coarse kelp POM contributed with 4.55 t·km⁻²·year⁻¹ (0.24% of total flow detritus) and fine kelp POM with 3.46 t·km⁻²·year⁻¹ (0.19% of total flow detritus), with a total 0.43% contribution. Coarse kelp POM consumption by organisms in the deep-sea ecosystem was 19.65 t·km⁻²·year⁻¹, whereas fine kelp POM consumption was 5.29 t·km⁻²·year⁻¹. This consumption values accounted for 1.55% and 0.42%, respectively, of whole detritus consumption in the ecosystem, and was mainly due to consumption of bacteria and detritivore polychaetes groups.

Both kelp detritus groups had a low impacting value on other groups of the ecosystem but they experienced high impacted values (Fig. 6). Specifically, the coarse kelp POM group was highly and negatively impacted by bacteria and benthic detritus and positively impacted by heterotrophic nanoflagellates. Fine kelp POM was highly negatively impacted by detritivore polychaetes and benthic detritus, and positively by predatory invertebrates.

Results from the theoretical time dynamic simulations showed large differences between both ADE models developed with (M1 and M2 together) or without mediation effects. The non-mediated ADE model showed minor effects in the biomass trends of all functional groups, except for suprabenthos group which decreased its relative biomass (0.82 times over initial biomass). Whereas the mediated ADE model presented noticeable impacts in the biomass of several functional

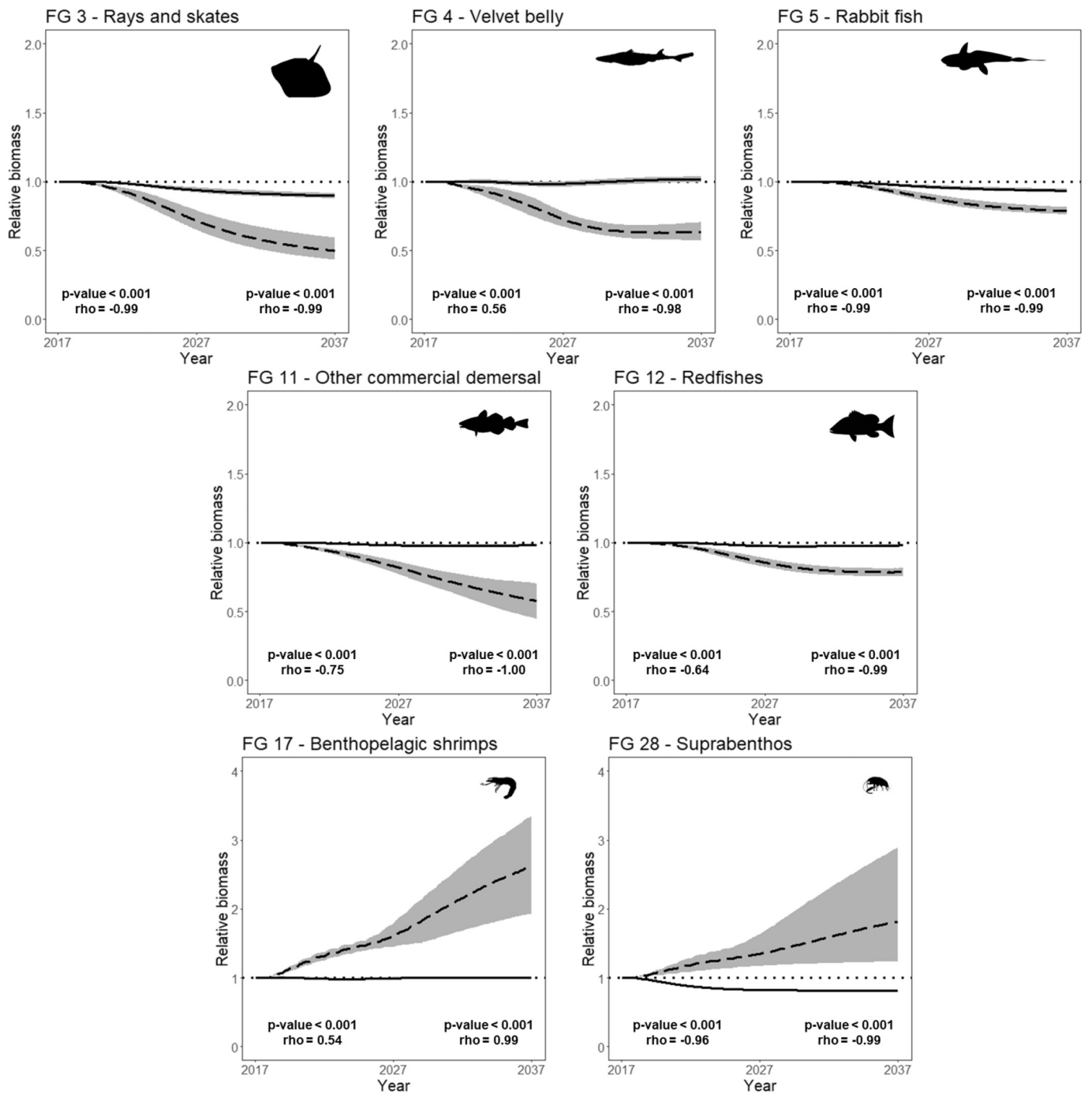

Fig. 8. Predicted time series of relative biomass ($t\text{-km}^{-2}$) for the most relevant functional groups regarding changes on biomass under low kelp POM biomass scenario for the ADEAKE model for the period 2017–2037. Black solid line represents mean non-mediated ADE model predictions and black dashed line represents mean mediated ADE model predictions. Shadows represent the 5% and 95% percentiles obtained using the Monte Carlo routine. Rho and *p*-value come from Spearman's rank correlation test ($n = 20$). Rho and *p*-values on the left side of the plot refer to non-mediated ADE model predictions, while rho and *p*-values on the right side refer to mediated ADE model predictions.

groups (Fig. 8 and Supplementary material Fig. B.3). For example, the biomass of benthopelagic shrimps and suprabenthos groups (2.62 and 1.81 times over initial biomass, respectively) increased when detritus of kelp decreased in the ecosystem as a result of the decreasing on their predation mortality. On the contrary, rays and skates, velvet belly, rabbitfish, other commercial demersal fishes and redfish groups decreased their relative biomass after 20 years of kelp POM depletion.

Ecological indicators showed similar values between the three ecosystem states (the ADEAKE, non-mediated ADE and mediated ADE), except for TC (Table 2). Total catch increased 100% in the mediated

ADE, whilst it was mostly constant in the non-mediated ADE (Fig. 9). The sum of exports over TST showed the greatest change and increased 10.21% in the non-mediated ADE model and 9.28% in the mediated ADE model after kelp POM biomass decreasing. Other ecological indicators changed only slightly with the decrease on kelp POM biomass: TBCo, O/C and FCI decreased, while A/C and FD increased. Results from species-based indicators showed low percentage of change or even no change for the non-mediated ADE model. Furthermore, percentage of change was high for some indicators in the mediated ADE model (Table 3 and Supplementary Material Fig. B.4). Specifically, biomass-

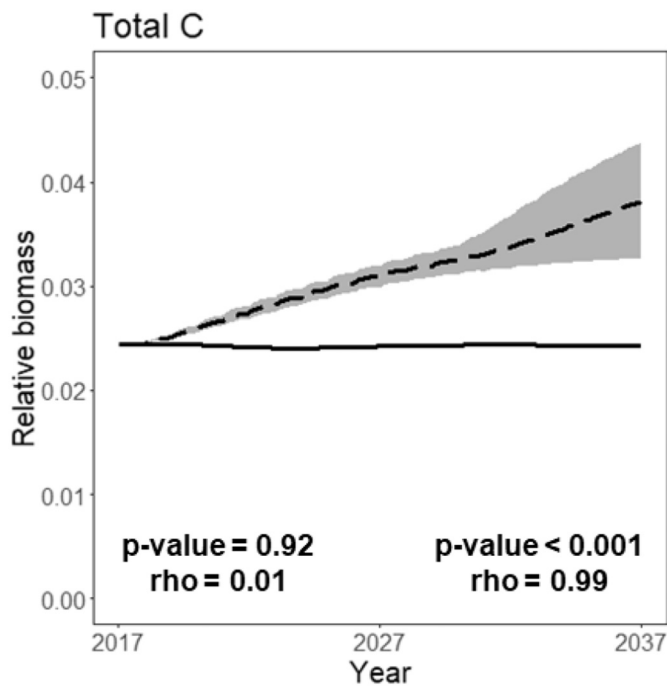

Fig. 9. Predicted time series of total catch ($t\cdot km^{-2}\cdot year^{-1}$) under a low kelp POM biomass scenario for the ADEAKE model for the period 2017–2037. Black solid line represents mean non-mediated ADE model predictions and black dashed line represents mean mediated ADE model predictions. Shadows represent the 5% and 95% percentiles obtained using the Monte Carlo routine. Rho and p-value come from Spearman's rank correlation test ($n = 20$). Rho and p-values on the left side of the plot refer to non-mediated ADE model predictions, while rho and p-values on the right side refer to mediated ADE model predictions.

based indicators showed the largest changes (fish biomass -15.36% ; commercial biomass 30.32% ; and Kempton diversity index -15.96%). On the contrary, trophic-based indicators showed mostly no changes.

4. Discussion

According to our results, kelp exported from shallow sub-tidal areas and entering deep-sea ecosystems has a moderate role in the deep-sea

ecosystem and a reduction of kelp POM to the system could have effects on some groups and ecosystem traits if mediating effects play an important role in the structure of deep-sea communities. Thus, these results suggest that kelp POM is moderately important to the structuring of the ecosystem, and the decrease on kelp POM imports has a weak bottom-up effect in the food web. Probably, this is due to the percentage of kelp POM consumption is quite low, and this could be connected to the low quality of this food source in terms of nitrogen enrichment, namely non-aged kelp detritus (Norderhaug et al., 2003). However, when we simulated a reduction of POM from the system, some species showed notable changes if mediation effects are considered in addition to direct prey-predation relationships. This illustrates how important the role of kelp detritus could be as habitat-forming species providing structure in the food web of the deep-sea ecosystem, in addition to being involved in direct trophic interactions.

4.1. Ecological role of kelp detritus and potential impact of its reductions

In general, ecological indicators related with ecosystem development theory (Odum, 1966, 1959), presented similar values in the ADEAKE and ADE models, suggesting that the overall structuring and functioning of the deep-sea ecosystem would not change significantly with kelp POM reduction. Kelp POM had low impact on the food web, however the model predicted a notable impact on functional groups that feed substantially on coarse and fine POM (predatory invertebrates, detritivore polychaetes, bacteria, heterotrophic nanoflagellates, and benthic detritus). This overall moderate role structuring the deep-ecosystem could be explained by the low consumption of kelp POM. In fact, degradation of kelp detritus occurs more slowly at lower water temperatures (Bedford and Moore, 1984; Rothäusler et al., 2009), such as Arctic ecosystems, and kelp detritus assimilation by benthic community could take many months.

Although studies based on stable isotopes analysis (Duggins et al., 1989; Fredriksen, 2003; McMeans et al., 2013; Renaud et al., 2015) highlighted the importance of kelp POM as a source of carbon, kelp POM appears to play a modest role in the ADEAKE food web due to low direct intake as food. This discrepancy between our results and previous work is in concordance with Miller and Page (2012), who suggested that contribution of kelp detritus to the diet of suspension feeders has been systematically overestimated by stable isotopes, and highlighted the difficulty of drawing conclusions about carbon source in those marine organisms. Furthermore, large accumulations of kelp POM were

Table 3

Species-based indicators for the Arctic Deep Ecosystem Associated to Kelp Exports for 2017 (ADEAKE), the non-mediated Arctic Deep Ecosystem for 2037 (non-mediated ADE) and the mediated Arctic Deep Ecosystem for 2037 (mediated ADE). Rho and p-value come from Spearman's rank correlation test ($n = 20$).

	ADEAKE		Non-mediated ADE		Mediated ADE			% change	
	Indicator value	Indicator value	Rho value	p-Value	Indicator value	Rho value	p-Value	ADEAKE vs non-mediated ADE	ADEAKE vs mediated ADE
Biomass-based indicators									
Biomass of fish species ($t\cdot km^{-2}$)	3.71	3.59	0.96	< 0.001	3.14	-0.99	< 0.001	-3.23	-15.36
Biomass of invertebrates' species ($t\cdot km^{-2}$)	91.44	91.00	-0.99	< 0.001	91.64	-0.23	< 0.001	-0.48	0.22
Biomass of commercial species ($t\cdot km^{-2}$)	1.88	1.86	-0.94	< 0.001	2.45	0.99	< 0.001	-1.06	30.32
Kempton's diversity index	4.01	4.03	-0.02	0.79	3.37	-0.99	< 0.001	0.50	-15.96
Trophic-based indicators									
TL of the catch	3.03	3.03	-0.96	< 0.001	2.94	-0.99	< 0.001	0.00	-2.97
TL of the community	1.35	1.36	0.99	< 0.001	1.31	0.99	< 0.001	0.74	-2.96
TL of the community including organisms with $TL \geq 2$	2.37	2.37	0.19	0.001	2.34	-0.62	< 0.001	0.00	-1.27
TL of the community including organisms with $TL \geq 3.25$	3.50	3.50	0.44	< 0.001	3.49	-0.99	< 0.001	0.00	-0.29
TL of the community including organisms with $TL \geq 4$	4.25	4.25	0.84	< 0.001	4.17	0.95	< 0.001	0.00	-1.88

not observed in the study area (Filbee-Dexter et al., 2018), and although kelp detritus does appear to enter this ecosystem, it may have low total biomass compared to other sources of non-living carbon.

Our results showed that it is not the total energy derived from kelp detritus, but rather its role in providing habitat structure with an altering behaviour of benthic species that has the strongest structuring effect on the food web. Non-mediated simulations did not show substantial changes on the biomass trend of functional groups under low kelp POM scenario, except for suprabenthos that decreased. This is due to kelp POM is one of their main sources of food (Dunton and Schell, 1987; Fredriksen, 2003; Renaud et al., 2015), and previous studies documented their strong association (Ramirez-Llodra et al., 2016). Despite the minor role of kelp POM in the whole ecosystem, our results showed important effects on the biomass of some functional groups after mediated simulations decreasing kelp POM biomass. Specifically, the most important changes were on benthopelagic shrimps and suprabenthos groups, suggesting a large influence of kelp POM on the dynamics of these groups. On the other side, biomass of rays and skates, velvet belly and rabbitfish groups decreased under low kelp POM scenarios because their consumption rate and feeding time increased. Benthopelagic shrimps and suprabenthos are important preys of those functional groups, and the trophic interactions between these groups (prey-predator) diminished as the mediating effects were applied under low kelp POM biomass scenarios. So, the lower coarse kelp POM biomass, the lower fish predation to benthopelagic shrimp and suprabenthos since they had less chance to concentrate in these macrophytic structures. Therefore, other commercial demersal fishes and red fishes reduced their biomass as a result of increasing of vulnerability to predation under low coarse kelp POM biomass scenario. Under this scenario, those fish groups had less chance to hide and avoid being predated during juvenile stages, and they were more predated by large fish feeders' group for example.

Such results underlined that the role of kelp POM may be highly dependent on its capacity to mediate prey-predator interactions because these structures can provide habitat heterogeneity on the deep-sea ecosystems (Bernardino et al., 2010). Habitat structure and complexity leads to an increase or a decrease in prey-predator interactions (Anderson, 2001; Johnson, 2006). Also, these structures can provide habitat heterogeneity on deep-sea ecosystems.

Predicted trend for species-based indicators suggested a degraded process on the ecosystem of kelp imports reductions, indicating that these changes of the state of the environment (biomass and biodiversity) may have an immediate impact on the functioning of the system and could affect its resilience in front other stressors (e.g. increasing of fishing effort). Trophic-based indicators also decreased, suggesting that a reduction of the kelp imports would reduce the trophic level of the community and catch. Results from trophic-based indicators were in line with the ones obtained from biomass-based indicators and may explain an impact on deep-sea ecosystem structure due to depletion of kelp POM. Usually, trophic-based indicators are used to track the effects of the fishing pressure (Coll et al., 2016; Shannon et al., 2014) although the direction of change in ecosystems indicators could be linked to multispecies assemblages, as well as to other factors such as environmental influences (Shin and Shannon, 2010). After analysing several ecosystems, Moore et al. (2004) determined that detritus groups often increase ecosystem stability, having substantial effects on trophic structure and biodiversity. These future impacts could reduce the resilience of deep-sea ecosystems to face other impacts such as climate change, or even could act synergistically (Beisner et al., 2003).

Despite the important role of mediating effects in ecosystem modelling (Harvey, 2014), there are only a few examples incorporating these effects into ecosystem models (Espinosa-Romero et al., 2011; Vasslides et al., 2017; Weijerman et al., 2018). In general, our results highlighted the importance of incorporating these functions in order to model mediating relationships, and the need of further research in the

field to obtain more accurate information about mediation effects to develop more realistic simulations (Harvey, 2014).

4.2. Ecosystem structure and functioning of the ADEAKE ecosystem

Overall, our results showed that the ADEAKE and Ullsfjord model share similar structural and functional traits. This may be related to the fact that input data of the ADEAKE model were extracted from the Ullsfjord model. The main difference between both ecosystems was the distribution of the flows through the ecosystem. Probably, this dissimilarity is due to different ecosystem traits, food-web structures and environmental influences of both areas (Heymans et al., 2014). Although these indicators are standardized by TST and they were robust to compare different models, the food-web structure could explain these difference (Heymans et al., 2014). Other indicators (FCI, SOI, and CI) showed higher values for the ADEAKE model, and could suggest a higher system maturity since the food chain is expected to change from linear to web-like as the system matures (Odum, 1956). These indicators are more dependent on food-web structure (Heymans et al., 2014). For example, the ADEAKE model was built to focus on exports from adjacent ecosystems, so it was parametrized with special emphasis on "biomass accumulation", "detritus flows" and "detritus fate" parameters.

The MTI analysis indicated that the most impacting group in the ADEAKE model was benthopelagic shrimps, so the effect that changes the biomass of benthopelagic shrimp group will have on the biomass of the other groups in the food web will be strongest in that system. Morissette et al. (2009) obtained similar results for shrimps' group in Arctic ecosystems. Keystoneness index for the ADEAKE model pointed at multiple functional groups as keystone. Among them, marine mammals were highlighted as keystone groups in previous northern studies (Bundy, 2001; Dommasnes et al., 2001). Large fish feeders' group and benthopelagic shrimps' group, which were grouped by important commercial species [such as the Atlantic halibut (*Hippoglossus hippoglossus*) and the northern shrimp (*Pandalus borealis*)], were identified as the main keystone species in the ecosystem. Similarly, Pedersen et al. (2016, 2008) identified another shrimp group (pelagic shrimps) and another large fish group (cod) as keystone groups in other northern Norwegian fjord models. Previous studies identified different species composition among connected fjords in Norway (Nøstvik and Pedersen, 1999; Zhou et al., 2005), and it may be the reason to differ on the keystone species analyses.

4.3. Fishing impacts

Fishing impacts were estimated to be moderate in the study area compared with similar ecosystems (Pedersen et al., 2016). Trawlers impacted negatively on some high trophic level groups (rays and skates, velvet belly and rabbitfish). However, this fleet incorporated devices on their gears in order to avoid the accidental catch of these species since 1993, and therefore, it is expected that this leads to a reduction of its estimated impacts (Grimaldo, 2006).

However, we observed moderate changes in species and ecosystem traits after kelp POM biomass reduction. Total Catch increased 100% in the mediated ADE model simulation, due to the increasing abundance of benthopelagic shrimps, mainly the northern shrimp *Pandalus borealis*, which is of great importance to fisheries in northern Norway (Eriksen, 2015). Low coarse kelp POM biomass caused less shrimp aggregation on these structures, so those crustacean species were less preyed upon by potential predators. This result illustrates that moderate changes in the ecosystem structure could affect ecosystem services when mediated effects are applied on predator-prey relationships.

5. Conclusions

This study represents the first attempt to model a deep-sea

ecosystem with special emphasis on the kelp detritus imports coming from adjacent ecosystems. Mostly, the Ecopath with Ecosim modelling approach has been applied to investigate several topics related to fisheries, ecosystem management or species dynamics (Coll  ter et al., 2015). This study highlights the importance of the inclusion of other flows of organic matter (such as kelp detritus) in such models. Our results suggest that kelp detritus plays a moderate role in the deep-sea ecosystem. When removed from the system, some species showed notable changes, although only if mediating relationships were considered, which could potentially impact ecosystem services such as food provision. Therefore, future reductions of kelp POM entering Arctic deep-sea ecosystems could affect the food web and biodiversity, contributing to changes in ecosystem structure and functioning traits. These effects underline how important the role of kelp detritus could be in providing non-trophic structure to the food web of the deep-sea ecosystem and call for further research in this field. To more realistically assess future changes of the Arctic deep-sea ecosystems, additional changes of kelp POM production on adjacent ecosystems should be included in future studies, such as increases in sea temperature (Kortsch et al., 2015), invasions of expanding species (Pedersen et al., 2018) or changes in fishing pressure (Mullon et al., 2016). This study represents a baseline from which scenarios with additional and cumulative stressors can be tested in the study area.

Acknowledgments

This work was funded by MARINFORSK Norwegian Research Council through the KELPEX project (NRC Grant no. 255085/E40). The authors wish to acknowledge Nina Mikkelsen, Emma K  llgren, Freija Hauquier, Margo Van Gyseghem and Ann Vanreusel for their help during the scientific survey. Also, the authors want to thank the crew of the R/V Johan Ruud. D.V. deeply thanks Andrea Obradors Puerto for contributing and helping with Figs. 2 and 3. MC acknowledges partial funding by the European Union's Horizon research program grant agreement No 689518 for the MERCES project. This research is part of POLARCSIC activities.

Appendix A. Supplementary data

Supplementary data to this article can be found online at <https://doi.org/10.1016/j.jmarsys.2019.103268>.

References

- Abdullah, M.I., Fredriksen, S., 2004. Production, respiration and exudation of dissolved organic matter by the kelp *Laminaria hyperborea* along the west coast of Norway. *J. Mar. Biol. Assoc. U. K.* 84, 887–894.
- Ahrens, R.N.M., Walters, C.J., Christensen, V., 2012. Foraging arena theory. *Fish Fish.* 13, 41–59.
- Anderson, T.W., 2001. Predator responses, prey refuges, and density-dependent mortality of a marine fish. *Ecology* 82, 245–257.
- Armstrong, E., Rogerson, A., Leftley, J.W., 2000. The abundance of heterotrophic protists associated with intertidal seaweeds. *Estuar. Coast. Shelf Sci.* 50, 415–424.
- Bedford, A.P., Moore, P.G., 1984. Macrofaunal involvement in the sublittoral decay of kelp debris: the detritivore community and species interactions. *Estuar. Coast. Shelf Sci.* 18, 97–111.
- Beisner, B.E., Haydon, D.T., Cuddington, K., 2003. Alternative stable states in ecology. *Front. Ecol. Environ.* 1, 376–382.
- Bekkby, T., Moy, F.E., Olsen, H., Rinde, E., Bodvin, T., B  e, R., Steen, H., Grefsrud, E.S., Espeland, S.H., Pedersen, A., 2013. The Norwegian Programme for Mapping of Marine Habitats—Providing Knowledge and Maps for ICZMP. *Global Challenges in Integrated Coastal Zone Management*, pp. 19–30.
- Bernardino, A.F., Smith, C.R., Baco, A., Altamira, I., Sumida, P.Y.G., 2010. Macrofaunal succession in sediments around kelp and wood falls in the deep NE Pacific and community overlap with other reducing habitats. *Deep-Sea Res. I Oceanogr. Res. Pap.* 57, 708–723.
- Bundy, A., 2001. Fishing on ecosystems: the interplay of fishing and predation in Newfoundland Labrador. *Can. J. Fish. Aquat. Sci.* 58, 1153–1167.
- Cage, J.D., 2002. Food inputs, utilisation, carbon flow and energetics. In: Tyler, P. (Ed.), *Ecosystems of the World*. Elsevier Science, Amsterdam, pp. 313–380.
- Carroll, J., Zaborska, A., Papucci, C., Schirone, A., Carroll, M.L., Pempkowiak, J., 2008. Accumulation of organic carbon in western Barents Sea sediments. *Deep-Sea Res. II Top. Stud. Oceanogr.* 55, 2361–2371.
- Chouvelon, T., Spitz, J., Caurant, F., M  ndez-Fernandez, P., Autier, J., Lassus-D  bat, A., Chappuis, A., Bustamante, P., 2012. Enhanced bioaccumulation of mercury in deep-sea fauna from the Bay of Biscay (north-east Atlantic) in relation to trophic positions identified by analysis of carbon and nitrogen stable isotopes. *Deep-Sea Res. I Oceanogr. Res. Pap.* 65, 113–124.
- Christensen, V., Walters, C.J., 2004. Ecopath with Ecosim: methods, capabilities and limitations. *Ecol. Model.* 172, 109–139. <https://doi.org/10.1016/j.ecolmodel.2003.09.003>.
- Christensen, V., Walters, C.J., Pauly, D., Forrest, R., 2008. *Ecopath With Ecosim Version 6: User Guide*. November 2008. Fisheries Centre, University of British Columbia, Vancouver, Canada, pp. 235.
- Christie, H.C., Gundersen, H., Rinde, E., Norderhaug, K.M., Fagerli, C.W., Bekkby, T., Gitmark, J.K., Pedersen, T., 2019. Can Multitrophic Interactions and Ocean Warming Influence Large-scale Kelp Recovery? (*Ecology and evolution*).
- Coll, M., Steenbeek, J., 2017. Standardized ecological indicators to assess aquatic food webs: the ECOIND software plug-in for Ecopath with Ecosim models. *Environ. Model. Softw.* 89, 120–130.
- Coll, M., Shannon, L.J., Kleinsner, K.M., Juan-Jord  , M.J., Bundy, A., Akoglu, A.G., Banaru, D., Boldt, J.L., Borges, M.F., Cook, A., 2016. Ecological indicators to capture the effects of fishing on biodiversity and conservation status of marine ecosystems. *Ecol. Indic.* 60, 947–962.
- Coll  ter, M., Valls, A., Guitton, J., Gascuel, D., Pauly, D., Christensen, V., 2015. Global overview of the applications of the Ecopath with Ecosim modeling approach using the EcoBase models repository. *Ecol. Model.* 302, 42–53. <https://doi.org/10.1016/j.ecolmodel.2015.01.025>.
- Corrales, X., Ofir, E., Coll, M., Goren, M., Edelist, D., Heymans, J.J., Gal, G., 2017. Modeling the role and impact of alien species and fisheries on the Israeli marine continental shelf ecosystem. *J. Mar. Syst.* 170, 88–102.
- Cury, P.M., Christensen, V., 2005. *Quantitative Ecosystem Indicators for Fisheries Management*. Oxford University Press.
- Dayton, P.K., 1985. Ecology of kelp communities. *Annu. Rev. Ecol. Syst.* 16, 215–245.
- Deehr, R.A., Luczkovich, J.J., Hart, K.J., Clough, L.M., Johnson, B.J., Johnson, J.C., 2014. Using stable isotope analysis to validate effective trophic levels from Ecopath models of areas closed and open to shrimp trawling in Core Sound, NC, USA. *Ecol. Model.* 282, 1–17.
- Dommasnes, A., Christensen, V., Ellertsen, B., Kvamme, C., Melle, W., Nottestad, L., Torstein, P., Tjelmeland, S., Zeller, D., 2001. An Ecopath model for the Norwegian Sea and Barents Sea. *Fish. Cent. Res. Rep.* 9, 213–240.
- Duggins, D.O., Eckman, J.E., 1997. Is kelp detritus a good food for suspension feeders? {Effects} of kelp species, age and secondary metabolites. *Mar. Biol.* 128, 489–495.
- Duggins, D.O., Simenstad, C.A., Estes, J.A., 1989. Magnification of secondary production by kelp detritus in coastal marine ecosystems. *Science* 245, 170–173.
- Dunlop, K.M., van Oevelen, D., Ruhl, H.A., Huffard, C.L., Kuhnz, L.A., Smith, K.L., 2016. Carbon cycling in the deep eastern North Pacific benthic food web: investigating the effect of organic carbon input. *Limnol. Oceanogr.* 61, 1956–1968.
- Dunton, K.H., Schell, D.M., 1987. Dependence of consumers on macroalgal (*Laminaria solidungula*) carbon in an arctic kelp community: $\delta^{13}C$ evidence. *Mar. Biol.* 93, 615–625.
- Eriksen, E., 2015. Survey Report From the Joint Norwegian/Russian Ecosystem Survey in the Barents Sea and Adjacent Waters, August–October 2014.
- Espinosa-Romero, M.J., Gregr, E.J., Walters, C., Christensen, V., Chan, K.M.A., 2011. Representing mediating effects and species reintroductions in Ecopath with Ecosim. *Ecol. Model.* 222, 1569–1579.
- Filbee-Dexter, K., Wernberg, T., 2018. Rise of turfs: {A} new battlefield for globally declining kelp forests. *BioScience* 68, 64–76.
- Filbee-Dexter, K., Wernberg, T., Norderhaug, K.M., Ramirez-Llodra, E., Pedersen, M.F., 2018. Movement of pulsed resource subsidies from kelp forests to deep fjords. *Oecologia* 1–14.
- Filbee-Dexter, K., Wernberg, T., Fredriksen, S., Norderhaug, K.M., Pedersen, M.F., 2019. Arctic kelp forests: diversity, resilience and future. *Glob. Planet. Change.* 172, 1–14. <https://doi.org/10.1016/j.gloplacha.2018.09.005>.
- Finn, J.T., Finn, 1976. Measures of ecosystem structure and function derived from analysis of flows. *J. Theor. Biol.* 56, 363–380.
- Fiskeridirektoratet, 2017. Unpubl. Data. Directorate of Fisheries. Government of Norway, Pb. 185 Sentrum, 5804 Bergen.
- Fredriksen, S., 2003. Food web studies in a Norwegian kelp forest based on stable isotope ($\delta^{13}C$ and $\delta^{15}N$) analysis. *Mar. Ecol. Prog. Ser.* 260, 71–81.
- Fuhrmann, M.M., Pedersen, T., Nilssen, E.M., 2017. Trophic niche of the invasive red king crab *Paralithodes camtschaticus* in a benthic food web. *Mar. Ecol. Prog. Ser.* 565, 113–129.
- Gardner, M.R., Ashby, W.R., 1970. Connectance of large dynamic (cybernetic) systems: critical values for stability. *Nature* 228, 784.
- Goody, A.J., Turley, C.M., 1990. Responses by benthic organisms to inputs of organic material to the ocean floor: a review. *Phil. Trans. R. Soc. Lond. A* 331, 119–138.
- Grimaldo, E., 2006. The effects of grid angle on a modified Nordm  re-grid in the Nordic shrimp fishery. *Fish. Res.* 77, 53–59.
- Harvey, C.J., 2014. Mediation functions in Ecopath with Ecosim: handle with care. *Can. J. Fish. Aquat. Sci.* 71, 1020–1029.
- Heymans, J.J., 2014. Ecological Indicators of Marine Food Webs. <https://doi.org/10.1371/journal.pone.0095845.g001>.
- Heymans, J.J., Coll, M., Liralato, S., Morissette, L., Christensen, V., 2014. Global patterns in ecological indicators of marine food webs: a modelling approach. *PLoS One* 9, e95845.
- Heymans, J.J., Coll, M., Link, J.S., Mackinson, S., Steenbeek, J., Walters, C., Christensen, V., 2016. Best practice in Ecopath with Ecosim food-web models for ecosystem-based management. *Ecol. Model.* 331, 173–184. <https://doi.org/10.1016/j.ecolmodel.2015.12.007>.
- Hooker, S.K., Iverson, S.J., Ostrom, P., Smith, S.C., 2001. Diet of northern bottlenose whales inferred from fatty-acid and stable-isotope analyses of biopsy samples. *Can. J. Zool.* 79, 1442–1454.
- Jennings, S., Greenstreet, S., Hill, L., Piet, G., Pinnegar, J., Warr, K.J., 2002. Long-term

- trends in the trophic structure of the North Sea fish community: evidence from stable isotope analysis, size-spectra and community metrics. *Mar. Biol.* 141, 1085–1097.
- Johnson, D.W., 2006. Predation, habitat complexity, and variation in density-dependent mortality of temperate reef fishes. *Ecology* 87, 1179–1188.
- Kain, J.M., 1971. Synopsis of Biological Data on *Laminaria hyperborea*. (Food and Agriculture Organization of the United Nations).
- Kelly, E., 2005. The role of kelp in the marine environment. *Irish Wildlife Manuals* 17.
- Kortsch, S., Prímecio, R., Fosshelm, M., Dolgov, A.V., Aschan, M., 2015. Climate change alters the structure of arctic marine food webs due to poleward shifts of boreal generalists. *Proc. R. Soc. B* 282, 20151546.
- Krause-Jensen, D., Duarte, C.M., 2016. Substantial role of macroalgae in marine carbon sequestration. *Nat. Geosci.* 9, 737.
- Krumhansl, K.A., Scheibling, R.E., 2012. Production and fate of kelp detritus. *Mar. Ecol. Prog. Ser.* 467, 281–302.
- Lalli, C., Parsons, T.R., 1997. *Biological Oceanography: An Introduction*. Elsevier.
- Larson, B.R., Vadas, R.L., Keser, M., 1980. Feeding and nutritional ecology of the sea urchin *Strongylocentrotus drobachiensis* in Maine, USA. *Mar. Biol.* 59, 49–62.
- Lindeman, R.L., 1942. The trophic-dynamic aspect of ecology. *Ecology* 23, 399–417.
- Ling, S.D., Scheibling, R.E., Rassweiler, A., Johnson, C.R., Shears, N., Connell, S.D., Salomon, A.K., Norderhaug, K.M., Pérez-Matus, A., Hernández, J.C., 2015. Global regime shift dynamics of catastrophic sea urchin overgrazing. *Philos. Trans. R. Soc. B* 370, 20130269.
- Link, J.S., 2010. Adding rigor to ecological network models by evaluating a set of pre-balance diagnostics: a plea for PREBAL. *Ecol. Model.* 221, 1580–1591. <https://doi.org/10.1016/j.ecolmodel.2010.03.012>.
- Lozano-Montes, H.M., Loneragan, N.R., Babcock, R.C., Jackson, K., 2011. Using trophic flows and ecosystem structure to model the effects of fishing in the Jurien Bay Marine Park, temperate Western Australia. *Mar. Freshw. Res.* 62, 421–431.
- Ma, H., Townsend, H., Zhang, X., Sigrist, M., Christensen, V., 2010. Using a fisheries ecosystem model with a water quality model to explore trophic and habitat impacts on a fisheries stock: a case study of the blue crab population in the Chesapeake Bay. *Ecol. Model.* 221, 997–1004.
- Mann, K.H., 2000. *Ecology of Coastal Waters: With Implications for Management*. Wiley.
- Masque, P., Marbà, N., Serrano, O., Krause-Jensen, D., Duarte, C.M., Lavery, P., Serrano, O., Marbà, N., Masque, P., Duarte, C.M., Marbà, N., Serrano, O., Krause-Jensen, D., Duarte, C.M., Lavery, P., 2018. Sequestration of macroalgal carbon: the elephant in the blue carbon room. *Biol. Lett.* 14, 20180236. <https://doi.org/10.1098/rsbl.2018.0236>.
- McMeans, B.C., Rooney, N., Arts, M.T., Fisk, A.T., 2013. Food web structure of a coastal Arctic marine ecosystem and implications for stability. *Mar. Ecol. Prog. Ser.* 482, 17–28.
- Miller, R.J., Page, H.M., 2012. Kelp as a trophic resource for marine suspension feeders: a review of isotope-based evidence. *Mar. Biol.* 159, 1391–1402.
- Moore, J.C., Berlow, E.L., Coleman, D.C., de Ruiter, P.C., Dong, Q., Hastings, A., Johnson, N.C., McCann, K.S., Melville, K., Morin, P.J., 2004. Detritus, trophic dynamics and biodiversity. *Ecol. Lett.* 7, 584–600.
- Morissette, L., Pedersen, T., Nilsen, M., 2009. Comparing pristine and depleted ecosystems: the Sørkjord, Norway versus the Gulf of St. Lawrence, Canada. Effects of intense fisheries on marine ecosystems. *Prog. Oceanogr.* 81, 174–187.
- Mullon, C., Steinmetz, F., Merino, G., Fernandes, J.A., Cheung, W.W.L., Butenschön, M., Barange, M., 2016. Quantitative pathways for Northeast Atlantic fisheries based on climate, ecological-economic and governance modelling scenarios. *Ecol. Model.* 320, 273–291.
- Navarro, J., Coll, M., Louzao, M., Palomera, I., Delgado, A., Forero, M.G., 2011. Comparison of ecosystem modelling and isotopic approach as ecological tools to investigate food webs in the NW Mediterranean Sea. *J. Exp. Mar. Biol. Ecol.* 401, 97–104.
- Nilsen, M., Pedersen, T., Nilssen, E.M., Fredriksen, S., 2008a. Trophic studies in a high-latitude fjord ecosystem—a comparison of stable isotope analyses ($\delta^{13}\text{C}$ and $\delta^{15}\text{N}$) and trophic-level estimates from a mass-balance model. *Can. J. Fish. Aquat. Sci.* 65, 2791–2806.
- Nilsen, M., Pedersen, T., Nilssen, E.M., Fredriksen, S., 2008b. Trophic studies in a high-latitude fjord ecosystem—a comparison of stable isotope analyses ($\delta^{13}\text{C}$ and $\delta^{15}\text{N}$) and trophic-level estimates from a mass-balance model. *Can. J. Fish. Aquat. Sci.* 65, 2791–2806.
- Nilsen, Pedersen, Nilssen, 2006. Macro-benthic biomass, productivity (P/B) and production in a high-latitude ecosystem, North Norway. *Mar. Ecol. Prog. Ser.* 321, 67–77.
- NMDC, 2017. Unpubl. Data. Norwegian Marine Data Center (NMDC) at Institute of Marine Research (IMR). Government of Norway, Mailbox 1870 Nordnes, 5817 Bergen.
- Norderhaug, K.M., Christie, H., 2011. Secondary production in a *Laminaria hyperborea* kelp forest and variation according to wave exposure. *Estuar. Coast. Shelf Sci.* 95, 135–144.
- Norderhaug, K.M., Christie, H.C., 2009. Sea urchin grazing and kelp re-vegetation in the NE Atlantic. *Mar. Biol. Res.* 5, 515–528.
- Norderhaug, K.M., Fredriksen, S., Nygaard, K., 2003. Trophic importance of *Laminaria hyperborea* to kelp forest consumers and the importance of bacterial degradation to food quality. *Mar. Ecol. Prog. Ser.* 255, 135–144.
- Nøstvik, F., Pedersen, T., 1999. Catching cod for tagging experiments. *Fish. Res.* 42, 57–66.
- Odum, E.P., 1959. *Fundamentals of Ecology*. (WB Saunders company).
- Odum, E.P., 1966. The strategy of ecosystem development. *science* 164.
- Odum, H.T., 1956. Efficiencies, size of organisms, and community structure. *Ecology* 37, 592–597.
- Opitz, S., 1996. *Trophic Interactions in Caribbean Coral Reefs*. (WorldFish).
- Pauly, D., Christensen, V., 1995. Primary Production Required to Sustain Global Fisheries. Pauly, D., Christensen, V., Dalsgaard, J., Froese, R., Torres, F., 1998. Fishing down marine food webs. *Science* 279, 860–863.
- Pedersen, M.F., Nejrup, L.B., Fredriksen, S., Christie, H., Norderhaug, K.M., 2012. Effects of wave exposure on population structure, demography, biomass and productivity of the kelp *Laminaria hyperborea*. *Mar. Ecol. Prog. Ser.* <https://doi.org/10.3354/meps09594>.
- Pedersen, T., Nilsen, M., Nilssen, E., Berg, E., Reigstad, M., 2008. Trophic model of a lightly exploited cod-dominated ecosystem. *Ecol. Model.* 214, 95–111.
- Pedersen, T., Ramsvatt, S., Nilssen, E.M., Nilsen, M., Morissette, L., Ivarjord, T., Systad, G., Kolsum, I., Fause, H., 2016. Species diversity affects ecosystem structure and mass flows in fjords. *Reg. Stud. Mar. Sci.* 3, 205–215.
- Pedersen, T., Fuhrmann, M.M., Lindstrøm, U., Nilssen, E.M., Ivarjord, T., Ramasco, V., Jørgensen, L.L., Sundet, J.H., Sivertsen, K., Källgren, E., 2018. Effects of the invasive red king crab on food web structure and ecosystem properties in an Atlantic fjord. *Mar. Ecol. Prog. Ser.* 596, 13–31.
- Pérez-Matus, A., Shima, J.S., 2010. Density- and trait-mediated effects of fish predators on amphipod grazers: potential indirect benefits for the giant kelp *Macrocystis pyrifera*. *Mar. Ecol. Prog. Ser.* 417, 151–158.
- Peterson, B.J., Fry, B., 1987. Stable isotopes in ecosystem studies. *Annu. Rev. Ecol. Syst.* 18, 293–320.
- Petursson, H., Falk-Petersen, S., Gislason, A., 2012. Trophic interactions of meso- and macrozooplankton and fish in the Iceland Sea as evaluated by fatty acid and stable isotope analysis. *ICES J. Mar. Sci.* 69, 1277–1288.
- Power, M.E., Tilman, D., Estes, J.A., Menge, B.A., Bond, W.J., Mills, L.S., Daily, G., Castilla, J.C., Lubchenco, J., Paine, R.T., 1996. Challenges in the quest for keystones. *BioScience* 46, 609–620.
- Ramirez-Llodra, E., Rinde, E., Gundersen, H., Christie, H., Fagerli, C.W., Fredriksen, S., Gitmark, J.K., Norling, K., Walday, M.G., Norderhaug, K.M., 2016. A snap shot of the short-term response of crustaceans to macrophyte detritus in the deep Oslofjord. *Sci. Rep.* 6, 23800. <https://doi.org/10.1038/srep23800>.
- Renaud, P.E., Løkken, T.S., Jørgensen, L.L., Berge, J., Johnson, B.J., 2015. Macroalgal detritus and food-web subsidies along an Arctic fjord depth-gradient. *Front. Mar. Sci.* 2, 31.
- Rothäuser, E., Gómez, I., Hinojosa, I.A., Karsten, U., Tala, F., Thiel, M., 2009. Effect of temperature and grazing on growth and reproduction of floating macrocystis spp (Phaeophyceae) along latitudinal gradient. *J. Phycol.* 45, 547–559.
- Sauchyn, L.K., Scheibling, R.E., 2009. Degradation of sea urchin feces in a rocky subtidal ecosystem: implications for nutrient cycling and energy flow. *Aquat. Biol.* 6, 99–108.
- Schaal, G., Riera, P., Leroux, C., 2012. Food web structure within kelp holdfasts (*Laminaria*): a stable isotope study. *Mar. Ecol.* 33, 370–376.
- Shaffer, J.A., Doty, D.C., Buckley, R.M., West, J.E., 1995. Crustacean community composition and trophic use of the drift vegetation habitat by juvenile splitnose rockfish *Sebastes diploproa*. *Mar. Ecol. Prog. Ser.* 123, 13–21.
- Shannon, L., Coll, M., Bundy, A., Gascuel, D., Heymans, J.J., Kleisner, K., Lynam, C.P., Piroddi, C., Tam, J., Travers-Trolet, M., 2014. Trophic level-based indicators to track fishing impacts across marine ecosystems. *Mar. Ecol. Prog. Ser.* 512, 115–140.
- Shin, Y.J., Shannon, L.J., 2010. Using indicators for evaluating, comparing, and communicating the ecological status of exploited marine ecosystems. 1. The indiSeas project. *ICES J. Mar. Sci.* 67, 686–691. <https://doi.org/10.1093/icesjms/isp273>.
- Steneck, R.S., Graham, M.H., Bourque, B.J., Corbett, D., Erlandson, J.M., Estes, J.A., Tegner, M.J., 2002. Kelp forest ecosystems: biodiversity, stability, resilience and future. *Environ. Conserv.* 29, 436–459.
- Teagle, H., Hawkins, S.J., Moore, P.J., Smale, D.A., 2017. The role of kelp species as biogenic habitat formers in coastal marine ecosystems. *J. Exp. Mar. Biol. Ecol.* 492, 81–98.
- Ulanowicz, R.E., Puccia, C.J., 1990. Mixed trophic impacts in ecosystems. *Coenoses* 7–16.
- Valls, A., Coll, M., Christensen, V., 2015. Keystone species: toward an operational concept for marine biodiversity conservation. *Ecol. Monogr.* 85, 29–47.
- Vanderklift, M.A., Wernberg, T., 2008. Detached kelps from distant sources are a food subsidy for sea urchins. *Oecologia* 157, 327–335.
- Vassilides, J.M., de Mutsert, K., Christensen, V., Townsend, H., 2017. Using the ecopath with ecosim modeling approach to understand the effects of watershed-based management actions in coastal ecosystems. *Coast. Manag.* 45, 44–55.
- Vetter, E.W., 1995. Detritus-based patches of high secondary production in the nearshore benthos. *Marine ecology progress series*. Oldendorf 120, 251–262.
- Walters, C., Christensen, V., Pauly, D., 1997. Structuring dynamic models of exploited ecosystems from trophic mass-balance assessments. *Rev. Fish. Biol. Fish.* 7, 139–172.
- Walters, C.J., Martell, S.J.D., 2004. *Fisheries Ecology and Management*. Princeton University Press.
- Weijerman, M., Gove, J.M., Williams, I.D., Walsh, W.J., Minton, D., Polovina, J.J., 2018. Evaluating management strategies to optimise coral reef ecosystem services. *J. Appl. Ecol.* 55, 1823–1833.
- Wernberg, T., Filbee-Dexter, K., 2018. Grazers extend blue carbon transfer by slowing sinking speeds of kelp detritus. *Sci. Rep.* 8, 17180. <https://doi.org/10.1038/s41598-018-34721-z>.
- Wernberg, T., Coleman, M.A., Bennett, S., Thomsen, M.S., Tuya, F., Kelaher, B.P., 2018. Genetic diversity and kelp forest vulnerability to climatic stress. *Sci. Rep.* 8, 1851.
- Wotton, R.S., Malmqvist, B., 2001. Feces in aquatic ecosystems: feeding animals transform organic matter into fecal pellets, which sink or are transported horizontally by currents; these fluxes relocate organic matter in aquatic ecosystems. *AIBS Bull.* 51, 537–544.
- Zaborska, A., Włodarska-Kowalczyk, M., Legeżyńska, J., Jankowska, E., Winogradow, A., Deja, K., 2018. Sedimentary organic matter sources, benthic consumption and burial in West Spitsbergen fjords—signs of maturing of Arctic fjordic systems? *J. Mar. Syst.* 180, 112–123.
- Zhou, M., Zhu, Y., Tande, K.S., 2005. Circulation and behavior of euphausiids in two Norwegian sub-Arctic fjords. *Mar. Ecol. Prog. Ser.* 300, 159–178.