

2-10-2014

New England Seaweed Culture Handbook

Sarah Redmond

University of Connecticut - Stamford, sarah.redmond@yahoo.com

Lindsay Green

University of New Hampshire - Main Campus, lae82@wildcats.unh.edu

Charles Yarish

University of Connecticut - Stamford, charles.yarish@uconn.edu

Jang Kim

University of Connecticut, jang.kim@uconn.edu

Christopher Neefus

University of New Hampshire, chris.neefus@unh.edu

Follow this and additional works at: http://digitalcommons.uconn.edu/seagrant_weedcult



Part of the [Agribusiness Commons](#), and the [Life Sciences Commons](#)

Recommended Citation

Redmond, Sarah; Green, Lindsay; Yarish, Charles; Kim, Jang; and Neefus, Christopher, "New England Seaweed Culture Handbook" (2014). *Seaweed Cultivation*. Paper 1.

http://digitalcommons.uconn.edu/seagrant_weedcult/1

This Article is brought to you for free and open access by the University of Connecticut Sea Grant at DigitalCommons@UConn. It has been accepted for inclusion in Seaweed Cultivation by an authorized administrator of DigitalCommons@UConn. For more information, please contact digitalcommons@uconn.edu.

New England Seaweed Culture Handbook

Nursery Systems



Sarah Redmond, Lindsay Green
Charles Yarish, Jang Kim, Christopher Neefus
University of Connecticut & University of New Hampshire

To cite this publication:

Redmond, S., L. Green, C. Yarish, J. Kim, and C. Neefus. 2014.

New England Seaweed Culture Handbook-Nursery Systems. Connecticut Sea Grant CTSG-14-01. 92 pp. PDF file. URL: <http://seagrant.uconn.edu/publications/aquaculture/handbook.pdf>. 92 pp.

Contacts: Dr. Charles Yarish, University of Connecticut. charles.yarish@uconn.edu

Dr. Christopher D. Neefus, University of New Hampshire. chris.neefus@unh.edu

For companion video series on YouTube, see: <http://s.uconn.edu/seaweedplaylist>



Connecticut Sea Grant
University of Connecticut
1080 Shennecossett Road
Groton, CT 06340-6048
<http://seagrant.uconn.edu>



Acknowledgments

This project was funded by the Connecticut and New Hampshire Sea Grant College Programs, and the New Hampshire Agricultural Experiment Station, Project Number R/A-38, under the title, “Development of Seaweed Culture System Technologies to Support Integrated Multitrophic Aquaculture and Sea Vegetable Aquaculture in New England Coastal Waters” (2/1/2010-1/31/2012). Additional support was provided by another Connecticut Sea Grant College Program project R/A-39, entitled “Seaweed Aquaculture for Bioextraction of Nutrients from Long Island Sound (2/1/2012-1/31/2014); NOAA SBIR I under the project title “Development of Native Kelp Culture System Technologies to Support Sea Vegetable Aquaculture in New England Coastal Waters” (7/1/2010-12/31/2010), and Long Island Sound Futures Fund (National Fish and Wildlife Foundation), under project title “Bioextraction of Nutrients from Long Island Sound” (1/3/2011-4/2/2012) and under another project title “Development of seaweed aquaculture for bioextraction of inorganic nutrients from the Bronx River estuary” (4/5/2012-01/04/2013). Principal investigators were Charles Yarish and Christopher D. Neefus.

Kelp and *Gracilaria* culture system technologies were developed at the University of Connecticut at the Stamford Seaweed Biotechnology Laboratory of Charles Yarish, with Sarah Redmond and Jang Kim. This project received additional funding from the Long Island Sound Futures Fund, and support from the Bridgeport Regional Aquaculture and Science Technology School in Bridgeport, Connecticut.

Chondrus and *Porphyra* culture technologies were developed at the University of New Hampshire’s Seaweed Research Laboratory of Christopher Neefus, with Lindsay Green.

We wish to thank Mr. John Curtis, the staff and students at the Bridgeport Regional Aquaculture and Science Technology School in Bridgeport, Connecticut for all their tireless efforts in developing the nursery and farm systems. We also wish to acknowledge the support of Mr. Adam Green and his staff at Rocking the Boat for their efforts and logistical support for the Bronx River estuary farm systems. The authors appreciate the efforts of Peg Van Patten, Connecticut Sea Grant, in the production and final editing of this handbook.

Preface

The seaweeds are a diverse group of large marine macroalgae that are as important to our near-shore coastal marine world as land plants are to our terrestrial world. Seaweeds were the evolutionary precursors to land plants, and like land plants, they are critical primary producers, forming living links between the inorganic and the organic world, using photosynthesis to convert CO₂ and nutrients into living biomass. These primary producers support other marine life through the production of oxygen, their contribution to marine food webs, and by providing structure and habitat for fish and invertebrates. Seaweeds are also an important resource for humans. Historically, coastal peoples have relied on seaweeds for food, minerals, medicine, insulation, fertilizer and fodder. Today seaweeds are a multi-billion dollar industry worldwide, providing food, fertilizers, nutritional supplementation, and valuable phycocolloid extracts including agar, carrageenan, and alginate.

Although wild harvest supports a significant portion of seaweed industry, there is an ever-increasing amount of seaweed production from aquaculture, principally in Asia and South America (Chile). Seaweed aquaculture makes up a significant portion of organisms cultured worldwide (~19 million metric tons) with a value of ~US \$5.65 billion (FAO, 2012). Aquaculture production is dominated by kelps (*Saccharina japonica* and *Undaria pinnatifida*), tropical red algal species (carrageenophytes species including *Kappaphycus* and *Eucheuma*), nori (including *Porphyra* and *Pyropia* species), and the red algal agarophyte species known as *Gracilaria*. China is the world's top producer of cultured seaweeds, though other countries in Asia (Japan, Korea, and the Philippines) and in Europe (France, Ireland, Norway, Scotland, and Spain) also grow seaweed. In North America, the seaweed industry is comprised of small wild-harvest cottage operations located along the East and West Coasts of Canada and the United States. Recent development in culture technologies, however, have led the to development of a small sugar kelp industry in the Northeast.

As populations expand, culture of seaweed will be important to supplement the wild resource. Seaweeds can be cultivated in the sea on suspended lines, rafts, or nets, or on land in tank-based culture systems. A sustainable, low- impact process, seaweed culture can provide much needed employment and independence to rural coastal communities. The development of a seaweed aquaculture industry can also encourage development of other aquacultured species that are higher up in the food chain. Seaweeds are bioextractive organisms, taking up excess nutrients generated by other species, such as fish or shrimp. The integrated culture of fed aquaculture (fish and shrimp) with extractive aquaculture (seaweed and shellfish) is called 'Integrated Multi-Trophic Aquaculture', or IMTA. The IMTA concept is an ecologically-based model that couples an inorganic bioextractive organism (seaweed) with an organic bioextractive organism (shellfish) to balance the intensive culture of fed organisms (finfish and shrimp), in order to produce a more sustainable, cleaner, and diversified aquaculture system (Neori *et al.*, 2007). The development of new, ecologically based, sustainable culture technologies will ensure future employment for coastal communities, healthier coastal ecosystems, and the protection of important wild populations.

There are many seaweed species in the Northeast with great economic and environmental potential. The three large kelp species—*Alaria esculenta*, *Laminaria digitata*, and *Saccharina latissima*—are eaten as healthy sea vegetables, usually sold as the "Atlantic" version of the similar Asian kelps (known as kombu or Wakame). They are an excellent source of iodine and other trace minerals, as well as a source of alginate, a phycocolloid used in many different industries (Sahoo and Yarish, 2005). Native red seaweeds include *Gracilaria tikvahiae*, *Chondrus crispus*, and *Porphyra/Pyropia* (previously referred to as *Porphyra*) species. *Gracilaria* species are cultivated at a large scale in some countries for food, as a feed for abalone, and for agar, an important phycocolloid in the food, medical, and microbiological industries. *Chondrus crispus* is eaten as a sea vegetable and used as a source of carrageenans, which are important in the food and consumer products industries as thickeners and stabilizers. *Porphyra* and *Pyropia* species (nori) species are cultivated on nets in Asia and are pressed and dried into the valuable nori sheets that are an integral part of the Asian diet. This manual serves as an introduction and instruction booklet for the nursery production and culture of the economically valuable seaweeds of New England, including locally occurring species of *Saccharina*, *Gracilaria*, *Porphyra* and *Chondrus*. It is our hope that it will be just the beginning of a successful and beneficial seaweed culture industry in the Northeast, whether for food, bioremediation, phycocolloids, animal feeds, biofuels, or any other of the potential uses of these versatile, wonderful seaweeds.

Table of Contents

Introduction	6
General Seaweed Culture System	8
Kelp	17
Biology	17
Cultivation	20
Culture Systems	21
<i>Gracilaria</i>	31
Biology	32
Cultivation	32
Culture Systems.....	38
<i>Chondrus crispus</i>	43
Biology	44
Cultivation	45
Culture Systems	49
Nori	54
Biology	55
Cultivation	58
Culture Systems	63
References & Suggested Readings	68
Appendix	
Lighting	75
Supplies	75
Laboratory	76
Nutrient Media	78
Nutrient Media Supplies Checklist	84
General Culture System Materials and Costs	85
Glossary	86
Index	90

Chapter 1. Introduction

Worldwide demand for seafood has increased steadily over the years, while for the past 20 years the amount of seafood harvested from wild populations has remained constant (FAO, 2002, 2003, 2006, 2010, 2012; New 1999). The increased demand has been met entirely through marine aquaculture, which is a multi-billion dollar industry (FAO, 2010, 2012; Figure 1.1). The United States is a major consumer of marine aquaculture products, yet we grow only a small fraction of what we consume (FAO, 2010). A major obstacle to the growth of a U.S. aquaculture industry has been the need to find environmentally sustainable methods of farming fish and crustaceans. Two issues of particular concern are 1) nutrient loading of coastal waters from effluent generated by coastal and shore-based fish aquaculture operations, and 2) the depletion of wild fish stocks harvested for fishmeal used in marine finfish aquaculture diets.

One goal for the development of domestic sustainable aquaculture is to ensure that commercial aquaculture has minimal adverse effects on the environment. One way to achieve this goal is through development of improved methods of waste management for land-based and coastal/offshore aquaculture. Fish excrete nitrogen, phosphorus and carbon dioxide (Beveridge 1987; Mugg, *et al.* 2000; Neori *et al.* 2004, 2007). Up to 49 kg nitrogen (N) and 7 kg phosphorus (P) can be released per ton of finfish produced per year (Chopin *et al.* 1999; Kautsky *et al.* 1996; Troell *et al.* 2003). In coastal waters, high levels of these nutrients can trigger harmful algal blooms and contribute to excessive growth of nuisance algae, which in turn have negative consequences on coastal ecosystems and the economy. These nutrients could instead be used to support the growth of economically important seaweeds (Neori *et al.* 2004; Chopin *et al.* 2008, Yarish & Pereira, 2008).

In Integrated Multi-Trophic Aquaculture (IMTA) systems and in nutrient bioextraction systems, whether land-based, coastal or offshore, seaweed can be used as an extractive component to remove inorganic nutrients and mitigate potentially adverse environmental impacts (Neori *et al.* 2004, 2007). Seaweeds take up nitrogen, phosphorus and carbon dioxide, which they use for growth and production of proteins and energy storage products.

When seaweeds are harvested from the IMTA or nutrient bioextraction systems, the nutrients are also removed from the system. The seaweed can then be used for human consumption, as a protein source in finfish aquaculture diets, as a source of pharmaceuticals, phycocolloids and other biochemicals, or as a carbon source for biofuel production (Horn *et al.* 2000).

On a global basis, seaweed aquaculture represents 24% of world marine aquaculture production on a weight basis and \$5.7 billion U.S. dollars on a monetary basis (FAO 2012). Nearly all seaweed aquaculture occurs in China, Korea and Japan. North America has very few seaweed aquaculture operations. The most notable in the Northeast is Acadian Seaplants, LLC, in Nova Scotia, Canada, producing the red seaweed *Chondrus crispus* for export to the Japanese food market (Craigie and Shacklock, 1995, Craigie *et al.* 1999). The primary commercial use of seaweed is as human food, either as sea vegetables or functional foods (Cordero, 2006; Nisizawa, 1987, 2006; Smit, 2004; Teas, 2006). Seaweeds are also used as a source of colloids for the food and cosmetic industries, as

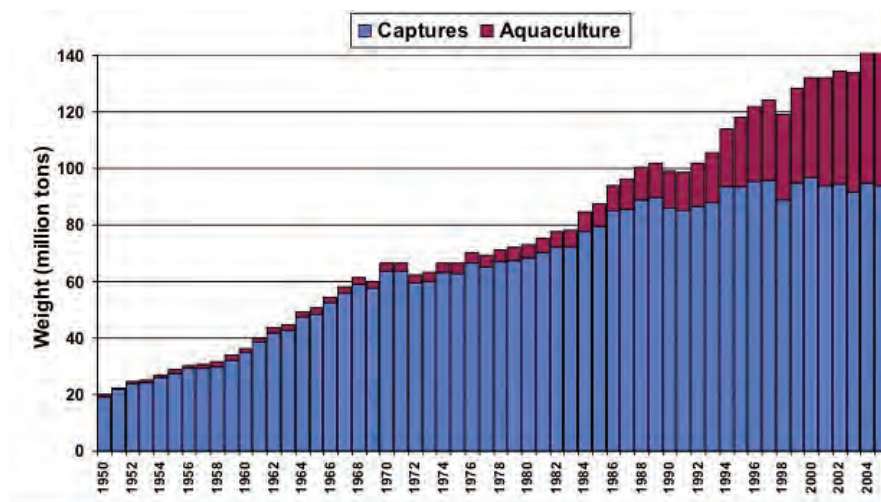

Figure 1.1 World capture fisheries and aquaculture.

Source: FAO *The State of World Fisheries and Aquaculture 2006*

an ingredient in pharmaceuticals and nutraceuticals, as a supplement in livestock feed and as a soil amendment in agriculture (Yarish and Pereira, 2008; Neori, 2008; Braden *et al.* 2007; Saker *et al.* 2003; Turner *et al.* 2002; Pereira and Yarish, 2010, Pereira *et al.*, 2012; Holdt and Kraan, 2011; Craigie, 2011; Browdy *et al.* 2012). They have been used as a food source for abalone and urchin aquaculture and is currently being investigated as a replacement for fishmeal in finfish diets (Neori *et al.* 2004; Neori *et al.* 2007; Robertson-Anderson *et al.* 2008; Francis *et al.* 2008, Walker *et al.* 2009). In the 1980s, there was significant interest in seaweeds as a biomass source for methane production (Flowers and Bird, 1984; Gao and McKinley 1994), and there is current renewed interest in seaweed as a biofuel source for ethanol and methanol production (Horn *et al.* 2000; Matsui *et al.* 2006; Yokoyama *et al.* 2007). However, the potential of most seaweeds as a feedstock for biodiesel is low, as the lipid content generally tends to below 5% dry weight except for some species of *Porphyra/Pyropia*, *Codium* and *Hypnea* (Sanchez-Machado *et al.* 2004; Pereira and Yarish, 2010). There are a number of potential applications for seaweeds in bioremediation; in addition to using seaweeds as an extractive component in IMTA and nutrient bioextraction systems (Neori *et al.* 2004; 2007; Chopin *et al.* 2008; Buschmann *et al.* 2008a; Kim *et al.* 2010) for production of food. Other non food production technologies utilize seaweed cultivation for habitat restoration (Carney *et al.* 2005), for potential large-scale carbon sinks, and as a method of removing heavy metals from marine environments (Davis *et al.*, 2003), and even as a way to detoxify and remove TNT from seawater (Cruz-Urbe *et al.* 2007).

Seaweeds have been successfully incorporated into a number of demonstration and pilot-scale IMTA and nutrient bioextraction systems. A pilot-scale coastal IMTA project in New Brunswick, Canada uses kelp (*Saccharina latissima* and *Alaria esculenta*) and mussels (*Mytilus edulis*) as the extractive components in close proximity to salmon (*Salmo salar*) net pens (Chopin *et al.* 2008). In Portugal, Matos *et al.* (2006) demonstrated the effectiveness of three red seaweeds, *Palmaria palmata*, *Gracilaria bursa-pastoris* and *Chondrus crispus* in removing nutrients from the effluent of tank-based production of turbot and sea bass. In Israel, Neori (1996) and Neori *et al.* (1996, 1999, 2000, 2003, 2004, 2007, 2008) have developed small commercial scale IMTA systems incorporating gilthead seabream (*Sparus aurata*), the green seaweed *Ulva lactuca*, abalone and sea urchins. In South Africa, kelp (*Ecklonia maxima*) grown in the effluent of abalone aquaculture tanks was fed back to the abalone. Nutrient load in the effluent was significantly reduced and more of the exogenous nutrients were converted to abalone biomass (Bolton *et al.* 2006; Troell *et al.* 2006; Robertson-Andersson, 2008; Francis *et al.* 2008). A trial of nutrient bioextraction in Long Island Sound and the Bronx River estuary used cultivated native strains of *Gracilaria tikvahiae* and *Saccharina latissima* (Kim *et al.* 2012).

To grow seaweed in an IMTA or nutrient bioextraction system, it is necessary to have a source of young plants. In Asia, native species have been isolated from wild populations; strains have been selected for desirable traits and are maintained as “seed” cultures. Seaweed farmers often belong to a cooperative and obtain “seed” nets or lines from a seaweed culture facility (i.e. a seaweed nursery). This manual describes how to set up a seaweed culture laboratory, defines the basic resource needs of the plants, and provides a culture system roadmap for the production of young seed plants.

Chapter 2. Seaweed Culture System

Every seaweed nursery or culture system requires a few main ingredients for successful culture. The three most important components of a culture system are seawater media (seawater and nutrients), temperature and light. This chapter offers a broad overview for laboratory system components that will be applicable to all types of seaweed culture. For more information on algal culturing techniques, the reader is urged to consult Andersen (2005).

Seawater

Successful seaweed culture requires a reliable supply of clean seawater. Natural seawater is preferred over artificial seawater, as natural seawater contains all of the essential mineral components (over 50 known elements) in the natural ratios, which may or may not be available in artificial seawater. Seawater should be clean and free of any organic or inorganic contaminants, with salinity between 28-34 parts per thousand (ppt). To avoid freshwater or terrestrial runoff, natural seawater collection should occur during periods of dry weather, preferably at high tide, and at depths of approximately 3 meters (10 feet) below the surface. Seawater can be collected by boat or from a shore facility with a well-placed intake pump. Water storage and transfer can be done in polyethylene tanks or 20-liter (5 gallon) carboys. All new containers need to be leached before use by filling with clean water (ideally distilled water, but clean seawater can be used) and allowed to sit for several days before rinsing for use. All containers and tanks should be well sealed to prevent contamination, and kept in a cool dark place to prevent growth of unwanted algae.

Seawater should initially undergo a coarse or rough mechanical filtration using sand filters (pool filters) or polyester bag filters with 20-35 micron pore sizes. Common household water filters set up in a series will allow for finer filtration. A basic three-step system moving down from 10 microns, to 5 microns, to 1 micron will filter out most particulates. Further fine filtration of 0.45 to 0.2 microns is important only for critical stages in the nursery. A 0.45-micron filter will separate out organics from dissolved inorganics, and filtering water down to 0.2 microns should eliminate almost all possible biological contaminants in the water, though organisms can get through if there are tears or holes in the filters. For this reason, further sterilization of the water and periodic inspection of filters may be necessary to eliminate any contaminants that could threaten the culture (Figure 2.1).

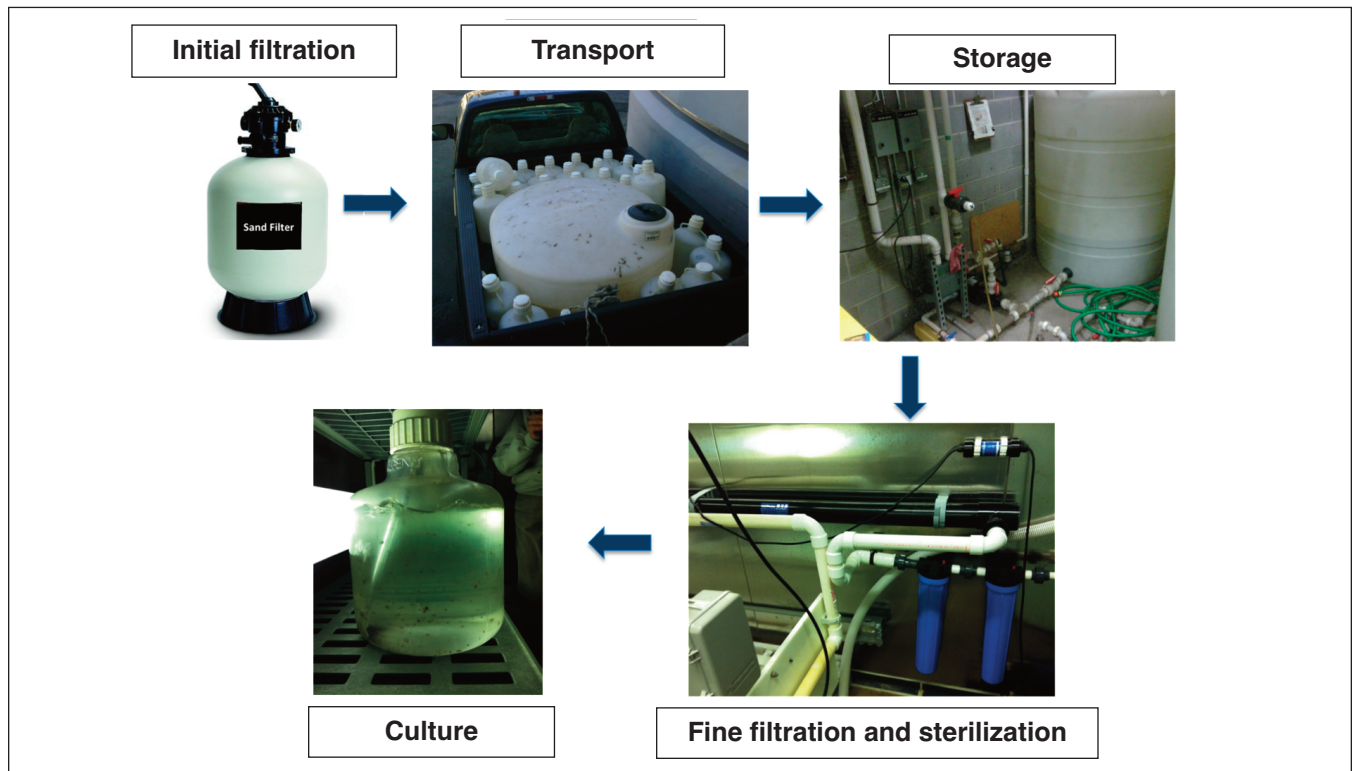

Figure 2.1. Seawater system.

Artificial seawater can be used, but is not recommended, for artificial mixes tend to have limited success compared to natural seawater. If it is necessary to use artificial seawater, a certain amount of experimentation may be required to determine the best source of mixed salts. They tend to be inconsistent, with great variability both between brands and within batches of the same brand. Artificial mixes may not have the same ratios of essential microelements present in natural seawater, which is why natural seawater is recommended for all culture work.

Sterilization

Once filtered, seawater should be sterilized, especially for culture initiation. While it is not necessary to have axenic (“pure”) cultures to grow seaweed, the microscopic and juvenile phases are sensitive to contamination. There are a host of microorganisms that can feed on, compete with, or overgrow the macroalgal cultures, including other algae, fungi, bacteria, cyanobacteria and micro zooplankton (primarily protozoans). Protozoan grazers can especially be a problem for the microscopic stages of kelp and other seaweeds, if present at high concentrations. The only way to completely ensure sterility of seawater is through heat treatment.

There are a few different methods available to sterilize seawater, and the best method will depend on the facilities available. Options are summarized in Table 2.1. The most effective method to sterilize seawater is by autoclaving, which ensures sterility through a treatment that applies extreme heat and pressure to seawater (Figure 2.2). Autoclaves are heavy walled closed chambers that can be used to sterilize liquids, metals, glass, or autoclavable plastics. Seawater can be sterilized in polypropylene, polycarbonate, or Pyrex containers. Containers should only be filled $\frac{3}{4}$ of the way, with loosely applied caps, to allow for pressure changes within the container during the heating and cooling of the liquid. Aluminum foil covers can be applied around the loose caps during the sterilization process to minimize exposure to air currents. A liquid cycle (121°C; 1-2 PSI, 15-30 minutes depending upon the volume of liquid) is sufficient to kill all living organisms, including bacteria, viruses, and



Figure 2.2. Autoclave.

heat resistant spores. In order to ensure the entire volume of liquid reaches the required temperature for a sufficient amount of time, containers should be allowed to equilibrate to the temperature of the warmed-up autoclave (30 min-1 hour) before running the cycle, and the cycle time should be increased for larger volumes of liquid. After the cycle has run, the door of the autoclave should not be opened until the pressure inside is the same as the room to avoid boiling over of the liquid.

Autoclaving can result in the formation of precipitates, especially phosphates, which are a critical micronutrient for seaweed growth. This occurs because the high temperature and pressure applied drives CO_2 gas out of the seawater, resulting in an increase in pH. Precipitation increases with higher levels of nutrients, so to avoid this, nutrient solutions are added after seawater has been autoclaved and cooled. Seawater should be removed from the autoclave when it is safe to do so, and allowed to cool at room temperature before storing in a cool dark place. It is best to store all sterilized water at 5-10°C to minimize chances of recontamination. Autoclaved seawater should be

allowed to sit for several days before using or aerated with regular air to restore CO_2 equilibrium and lower pH levels. If a traditional autoclave is not available, a large pressure cooker may be used to apply heat and pressure to sterilize smaller amounts of water in the same way.

Seawater can be sterilized by application of heat only, through the processes of pasteurization and tyndallization. Pasteurization is accomplished by heating seawater up to a boiling point, to 90-95°C for 30-60 minutes, and then cooling rapidly to less than 10°C. Tyndallization applies the process of pasteurization three consecutive times to the liquid, over the course of three days. This method takes longer to accomplish, but provides extra treatment to kill heat resistant spores that will not be effectively destroyed in the first pasteurization. This can be accomplished with a stovetop or a microwave oven, making sure that the seawater is well covered to avoid contamination.

Another way to sterilize water by application of heat is through flash sterilization. This will kill most organisms in seawater, but may not kill heat resistant spores. This method heats water up to a high temperature (70-90°C) in a very short time by passing through a tube or plate heat exchanger. This may not kill all possible contaminants, but can be an effective way to treat larger amounts of seawater.

Filter sterilization of liquid uses very fine filtration to exclude all living organisms, effectively sterilizing water without the application of heat. This method is used for small volumes of seawater or heat sensitive liquids, such as nutrient media and vitamin solutions. Liquid is filtered through a 0.2-micron filter, which, in theory, should exclude all organisms, though imperfections or defects in the filter pore size can reduce effectiveness. For small volumes, a reusable or disposable filter assembly is set up on a side arm flask, and liquid is pulled through the filter using a vacuum pump. Fine filtering can also be a part of a multi canister filter system, where seawater is pumped through a series of decreasing filter sizes.

A filtering system coupled to a UV light system can provide extra treatment of seawater. Enclosed high-energy UV bulbs can be installed as part of the water filtration process. Filtered seawater passing through a UV sterilizer will be exposed to UV radiation, destroying any remaining organisms that may have passed through the filter. UV radiation may not be 100% effective, but can be an additional treatment to incoming seawater or water that cannot be autoclaved or heat sterilized.

Seawater can be sterilized with a chlorine treatment by adding liquid bleach to sterilize, followed by sodium thiosulfate to neutralize. After water is filtered to remove organic matter, bleach (5% sodium hypochlorite) is added at concentrations of 1-5 mL of bleach per liter of seawater. Water should be left to stand for several hours, avoiding exposure to direct sunlight. After treatment, the bleach needs to be sufficiently neutralized before using. To neutralize, a sodium thiosulfate solution ($\text{Na}_2\text{S}_2\text{O}_3 \cdot 5\text{H}_2\text{O}$) is added at concentrations of 1 mL per 4 mL bleach added. The sodium thiosulfate solution is made by dissolving 250 grams of $\text{Na}_2\text{S}_2\text{O}_3 \cdot 5\text{H}_2\text{O}$ in 1 liter of water (Kawachi and Noel, 2005). Neutralization of seawater should be verified with a chlorine test kit.

Table 2.1 . Seawater sterilization options

Seawater Sterilization Options			
Method	Temperature	Time	Notes
Autoclave	121°C	15-30 min (entire volume)	Containers filled 3/4, loosely applied covers
Pasteurization & Tyndallization	Heat 90-95°C, Cool 10°C	Heat 30-60 min., rapidly cool	Repeat 3 times over 3 days
Flash Sterilization	70-90°C	Rapid heating of seawater passing through heat plates	For large amounts of seawater
UV Sterilization	n/a	Seconds of contact time	Most effective in recirculating water systems
Chlorine Treatment (5% sodium hypochlorite, added at 1-5 mL/L seawater)	n/a	30 min - 24 hrs	Neutralize with sodium thiosulfate solution (1 mL per 4 mL bleach)
Filter Sterilization	n/a	n/a	Filter size 0.2 microns, for heat-sensitive liquids

Nutrient Media

While natural seawater contains many of the necessary trace elements needed for seaweed culture, the quality and amount of nutrients can be variable and insufficient for culture work. Both natural and artificial seawater need to be enriched with a concentrated nutrient solution after the water has been sufficiently sterilized. There are several different types of media, but all provide a mixture of essential macronutrients (nitrogen, phosphorus, calcium, potassium, sodium, chloride, etc.) and trace elements (iron, manganese, zinc, molybdenum, copper, cobalt, zinc, etc.), metal chelators (EDTA), vitamins (B₁₂, thiamine, biotin), and hydrogen ion and metal-ion buffers (TRIS, EDTA). Reagent laboratory-grade chemicals should be used to reduce the likelihood of contamination or impurities. Macronutrient, trace metal, and vitamin solutions are usually made up separately then



Figure 2.3. Vacuum pump assembly for filter sterilization ($0.2 \mu\text{m}$) of nutrient media (top). Filter assemblies can be disposable (left, bottom) or reusable (right, bottom).

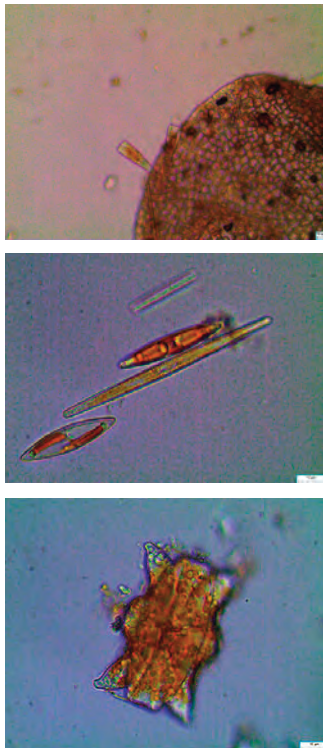

Figure 2.4. Diatoms problematic in seaweed culture. Top: diatom embedded in kelp blade. Middle: pennate diatoms. Bottom: Centric diatom. Scale bars = 10 microns

added together to produce the concentrated stock solution. All solutions should be filter sterilized and refrigerated. Vitamin solutions can be frozen or refrigerated, but care should be taken to maintain sterility (Harrison & Berges, 2005).

Nutrient solutions are made up in large quantities beforehand, filter-sterilized into clean stock bottles, and refrigerated. It is useful to pre-proportion the nutrient solution into smaller bottles that are ready to be added to the volume of the culture tank to make seawater preparation easier. Preparation of enrichment solution requires a clean sterilized table space, clean sterilized glass or plastic ware, and sterile techniques. Only non-reactive metal instruments or glass should be used, as some latex and rubber can be toxic if leached into the media. Reusable glass filter units with disposable filter papers (0.2 micron) or disposable bottle top filters are placed into the mouth of a side-arm flask, and the liquid is pulled through the filter paper by suction underneath, created by a vacuum pump (Figure 2.3). Instructions for preparation of this media can be found in Appendix A.

Seawater must be changed regularly during the culture period to replenish nutrients for growing plants. This is a simple operation that involves transferring plants from one culture vessel to a new one with fresh seawater media, taking care that the new culture water is at the same temperature as the old culture water to avoid stressing the seaweed. This should be done in a clean environment, using sterilized forceps and gloves, avoiding any chance of contamination through air currents or contact. Culture changes are usually done once per week or more in actively growing or dense cultures, and once every two to four weeks in cultures that are just being maintained and not actively growing.

Diatoms

Diatoms are the most common and problematic contaminants in a seaweed culture. They are single-celled microalgae (phytoplankton) (Figure 2.4) characterized by unique symmetric cell walls made of silica. Centric diatoms are radially symmetrical (round), while pennate diatoms are bilaterally symmetrical (long and

thin). Diatoms can exist as single cells, colonies, or filaments. They reproduce rapidly once introduced, and can smother culture substrate and young blades. They are usually introduced through natural seawater or from blades brought in from a wild collection. Their small size and variable shapes allow them to pass through most filtration systems and even UV sterilization. They usually show up in any seaweed nursery, even with the most careful precautions. It is a good idea to check cultures under the microscope often for diatoms to catch them early on. Usually a brownish growth on a tank wall or culture string is a good indication that they have been introduced.

To control diatoms in cultures, a saturated solution of germanium dioxide is added to the culture media at 1-2 mL per liter of seawater. Germanium dioxide inhibits silica uptake, which is necessary for cell wall formation. It keeps diatoms from being able to reproduce, and effectively eliminates diatoms in the culture (Lewin, 1966). Germanium dioxide should only be used when initiating cultures, and will not be a cost effective measure in large volumes of water. It should be used sparingly, especially in kelp cultures, as high concentrations can be harmful to brown algae.

Temperature

Water temperature control is an important element in any seaweed nursery operation. Seaweeds have an optimal temperature range for growth, as well as a range of upper and lower survival temperatures (see Lüning, 1990 for a general introduction to environmental factors regulating seaweed growth and production). Cultures can either be placed inside a refrigerated space (cold rooms or incubators) or in individual tanks that may be cooled with a seawater chiller (Figure 2.5). If standard household refrigerators are available they can be converted into homemade incubators by installing fluorescent lights on the inside walls, with ballasts placed outside. Temperature alarm monitoring systems with automatic dialers can alert culturists in the event of a temperature failure. Omega Systems make a variety of these alarms monitoring devices.



Figure 2.5. Environmental culture chambers, also known as incubators. These can be any size, and can be purchased commercially or can be homemade. Environmental chambers all have a means of temperature control, a light source with photoperiodic control, and aeration. Left: Hotpack brand incubator. Middle: Percival Biological incubator, Right: Room-sized environmental chamber.

Lighting

Seaweeds are photosynthetic organisms that incorporate inorganic materials into organic biomass using the energy of the sun. Seaweeds utilize photosynthetically active radiation (PAR), which is the portion of light available for photosynthesis. PAR comprises the same part of the light spectrum as visible light, and can be broken down into its colored components, from blue/violet (400nm, high energy) to yellow/red (700nm, low energy). The underwater light environment is highly variable and dynamic, because as light passes through water it is absorbed and scattered by water molecules and particles. The longer, lower energy red wavelengths are usually absorbed near the surface, while shorter, higher energy blue wavelengths penetrate deeper into the water column. While all of the algal groups (green, red, and brown) contain chlorophyll *a* and carotenoids, they have different photosynthetic accessory pigments. Each type of pigment absorbs wavelengths in different parts of the

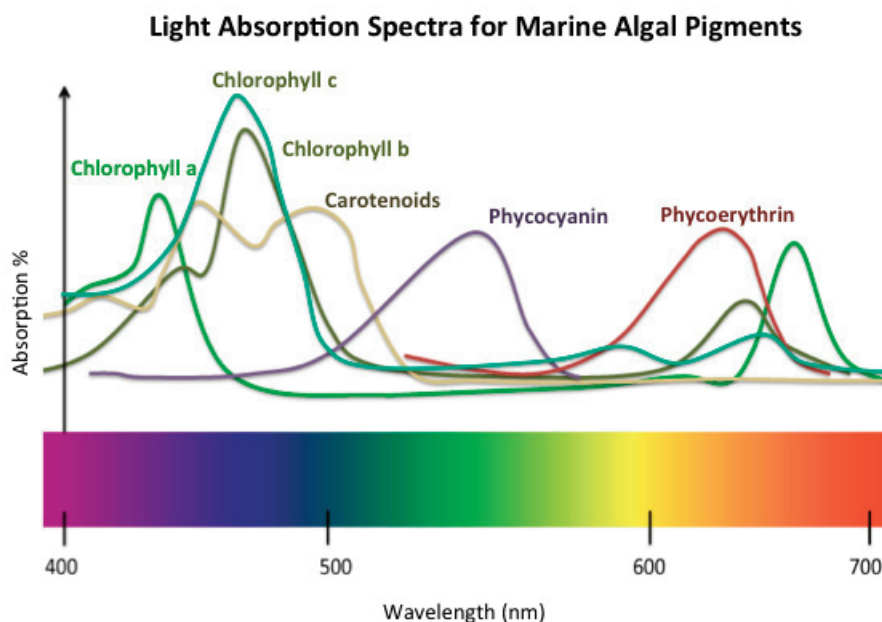

Figure 2.6. Light absorption spectra for photosynthetic pigments

spectrum, as shown below (Figure 2.6), and only certain wavelengths elicit a physiological response (often referred to as the action spectrum).

In the laboratory, fluorescent light bulbs will provide sufficient light energy for the culture of plants. There are many different varieties of bulbs on the market, and the technology is ever evolving, so it is helpful to understand what type of light each bulb offers. Light quality and quantity are important when choosing a bulb. Higher output bulbs will provide higher light intensity or photon-fluence levels. For this reason, the “high output” bulbs (or “HO”) are used in order to ensure enough light. The quality of light available from each type of bulb is determined by the inside coating of the glass. There are three main types of bulbs, differentiated by their color temperature. The color temperature is a value in Kelvins printed on the bulb. Daylight bulbs have the highest color temperature, at 5000K or above, and are made to simulate natural sunlight. Cool white bulbs have more light in the blue, with a color temperature around 4000K. Warm white bulbs emit light in the red portion of the spectrum, with a lower color temperature of 3000K or less. Cool white bulbs are best, because most of the photosynthetic pigments in algae are able to absorb light in the blue portion of the spectrum (Figure 2.7).

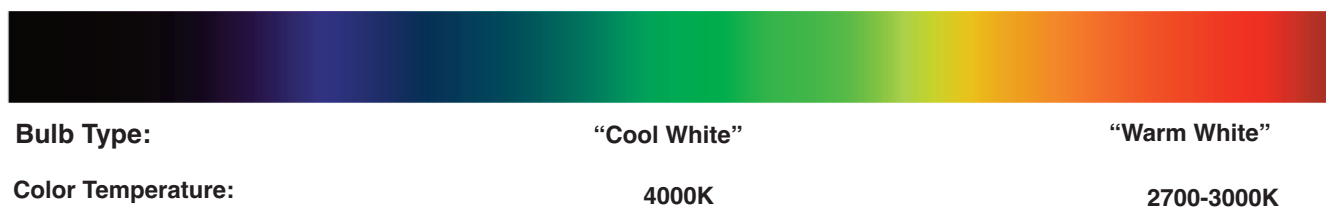

Figure 2.7. Fluorescent bulb color temperatures

To provide artificial lighting in the laboratory or indoor culture facility, cool white high output T12 fluorescent bulbs with electronic ballasts are best. However, more energy efficient bulbs including T8 and T5 technologies are now replacing T12 bulbs. The spectral composition of all the bulbs are not equivalent, and it remains to be seen if the newer technologies will provide the same results as the older T12 bulbs. The spectral compositions of all these bulbs are readily available by the manufacturers including General Electric, Phillips and Sylvania. Light can be provided from above or from the sides of clear containers, and several independently

controlled bulbs can be used to increase or decrease light levels. Window screening can also be used to control light intensity by placing layers between the light source and the cultures, each layer of 1mm mesh screen resulting in a 40-50% reduction in light.

It is important to know the intensity of light available to plants, as light requirements change over time. Usually, new cultures require lower light levels, while developing plants require more. Very low light levels (1-10% of normal culture conditions) can be used to maintain cultures over a long period of time. Quantum light meters are used to measure the amount of light available for algal growth, and measure photosynthetic photon flux density, given in units of micromoles of photons per meter squared per second ($\mu\text{mol m}^{-2} \text{s}^{-1}$). Very good handheld meters (e.g. Apogee Instruments, LI-COR) can be found on the Internet for order.

Lights should be connected to an interval timer to control photoperiod. Photoperiod is the alternating period of light and dark, which is very important for normal development and growth of seaweeds. A neutral photoperiod is commonly used, which is 12 hours light followed by 12 hours of darkness (12:12, L:D). To establish the photoperiod, all outside light sources (such as windows or other light fixtures) should be eliminated. A long day photoperiod consists of long days and short nights, usually 14-16 hours of light followed by 8-10 hours of darkness. A short day photoperiod consists of only 6-8 hours of light followed by 16-18 hours of dark. Algae reproduction and growth is often triggered by changes in photoperiod and/or temperature, so manipulating photoperiod is a useful tool in a culture center (see Lüning, 1990, for further information on photoperiod).

Laboratory

Basic laboratory equipment



Figure 2-8. Dissecting (left) and compound (right) microscope.

A compound microscope is essential to determine successful spore release, spore density, and development of microscopic stages (Figure 2.8). A high-powered dissecting scope is also very useful for monitoring larger plants throughout the culture period, or for isolating spores. Microscope accessories include lens paper, Windex or alcohol, and glass slides and coverslips. A haemocytometer, specially etched for the counting of microscopic cells, is useful for spore solution density determination (Figure 2.9).

A refractometer is a simple handheld tool that measures salinity of seawater. A pH meter is required for adjusting culture media pH during preparation, as well as for monitoring cultures. pH meters need to be calibrated with buffer solutions before each use, rinsed before and after each use in deionized water, and stored in an electrode storage solution. A magnetic stir plate with stirrer bars is used for preparing nutrient media solutions.

Glass and plasticware for the lab will include volumetric flasks, graduated cylinders, beakers, flasks, and various culture dishes.

Borosilicate glass, Teflon, and polycarbonate are all common laboratory materials. Any material used in the lab should be non-reactive and non-toxic, and thoroughly cleaned before use. New glass or plasticware needs to be pre-cleaned before use. This is done by washing, soaking in a dilute 10% hydrochloric acid solution, followed by a soaking in deionized water for 1-2 days. This step ensures the removal of any residue or chemical that could leach into the seawater or nutrient media. All lab ware should be carefully washed using laboratory detergent, rinsed in tap water, followed by a rinse in deionized water to remove any residuals (nutrients, chemicals, or metals) that can be present in tap water. All types of rubber or metal should be avoided, and new tubing should be thoroughly rinsed before use. The size and type of glassware will depend on the needs of the grower. Glassware, brushes, and glassware detergents are available from laboratory supply companies. If buildup occurs on glassware with use, it can be soaked in a 10% hydrochloric



Figure 2-9. A haemocytometer.

acid bath for at least several hours, and then rinsed twice with deionized water. Acid baths should be prepared with proper protective equipment (goggles, gloves, and apron) and stored in a closed container to avoid evaporation. Any critical portion of the culture process should utilize only clean, rinsed, covered and sterile glassware to avoid any contamination.

Washed, dried, and sterilized glassware should be stored in a clean cupboard, away from air currents. Figure 2.10 illustrates some useful items for the lab.



Figure 2.10. Useful lab items.

Glassware, tanks, and all laboratory equipment and working spaces should be clean and sterile to avoid contamination in cultures. Glassware and metal instruments can be sterilized by applying moist heat or dry heat. Moist heat is applied in an autoclave or pressure cooker, (1-2 bars of pressure at 121°C), making sure the steam penetrates the material, and caps (either aluminum foil or a plug) are applied loosely to containers. Dry heat can be used to sterilize glass or metal, by heating in an oven for 3-4 hours at 150°C. Aluminum foil is used to cap or cover equipment, ensuring that all openings are covered to maintain sterility upon removal from oven or autoclave.

To minimize risk of airborne contaminants, the culture working station should be clean and free of outside air currents. In the lab, this type of environment is set up in a laminar flow cabinet or a biological safety cabinet (Figure 2-11). If these types of clean hoods are unavailable, a clean working station can be set up in a clean room with no open windows or doors. To set up a clean working station, the working surface should be cleaned



Figure 2-11. Two types of clean hoods. Left, a biological safety cabinet, suitable for working with cultures or hazardous materials. Right, a laminar flow cabinet, suitable for working with cultures and non-hazardous materials.

with a microbial disinfectant. A 70% Ethyl alcohol solution, Amphyl[®] cleaner & disinfectant, or a bleach solution in a spray bottle can be used to clean and sterilize surfaces and equipment. You can also use a 70% or a 95% solution of ethyl alcohol for sterilizing stainless steel tools (forceps, dissecting needles, blades). An open flame from an oil lamp or gas burner will allow for heat sterilization of metal tools that are dipped in the ethyl alcohol solution.

A record of all cultures in the lab, nursery, or culture center should be kept in the lab with the source, history, and details of all of the cultures. This will allow the grower to track cultures over time. All cultures, chemicals, and seawater media should be well labeled, and appropriate federal and state laws should be followed in the handling, storage, and disposal of all chemicals and cultures.

Long-Term Maintenance

It is a good idea to maintain stock cultures (backup cultures) of all cultivars in the lab. Stock cultures should be kept at lowered temperatures and light levels to minimize growth and need for culture changes. For long-term maintenance, cold-temperate plants should be kept at 5-10°C, warm temperate plants at 15-20°C. Illumination is best kept at 1-10% of normal culture conditions, which is at or near compensation level (generally 2-7 $\mu\text{mol photons m}^{-2} \text{s}^{-1}$).

Chapter 3. Kelp

“Kelp” is a general name sometimes given to both kelps and rockweeds because of the so-called “kelp ash” that was once made from burning both types of brown algae, but for the purposes of this manual it will refer to a particular order within the Class Phaeophyceae. This order, Laminariales, (from the Latin word ‘lamina’, which means “thin sheet”) contains several commercially important species within seven different families (Figure 3.1). All of the plants within the order have the same basic life cycle and can be cultivated using the same techniques. The life cycle has two phases—a large, conspicuous phase that can form large underwater forests and meadows, and a microscopic phase that is impossible to view with the unaided eye. These are principally cold-water seaweeds, found in cold temperate and polar climates worldwide. Kelps have unique physiological properties that allow them to survive under ice, in near-darkness, and in high-energy environments, and these same properties make them a valuable natural resource. The increasing demand for kelp and kelp products, high growth rates, a winter growing season, and high biomass production makes these species excellent candidates for aquaculture.



Figure 3.1. *Saccharina latissima*, the “sugar kelp”

Kelp is a healthy and nutritious sea vegetable, high in fiber, vitamins, and minerals, including vitamin C, vitamin K, iron, calcium, iodine, and magnesium.

Kelp has long been part of the diet of Asian cultures, and, in fact, *Saccharina japonica* (formerly called ‘*Laminaria japonica*’), which is a relative of our native *Saccharina latissima*, is the number one aquacultured species worldwide by weight (FAO, 2010, 2012). Most of the kelp on the market in the US is wild harvested, though development of a kelp culture industry is currently underway that can help supplement the harvest of wild stocks as demand increases. A versatile vegetable, it can be used dried, powdered, fresh, cooked, and frozen. Kelp is currently available in health food stores as a dried or frozen sea vegetable, as powder, flakes, pills, soup and snack food components. Alginate, or alginic acid, is a polysaccharide found in the cell walls of brown algae. The alginate in can absorb and remove heavy metal and radioactive ions in the body, and there has been some indication that it can assist in weight loss due to its water absorption properties. Alginate is a gel-forming phycocolloid that is extracted and used as an additive in the food processing industry for bulking, stabilizing, and smoothing food products. Non-food uses of kelp include utilization of alginate in the paper, textile, manufacturing, laboratory and biomedical industries, and as a nutritional supplement in animal feeds. Kelp has also been considered as a source of biomass for the production of biogas or bioethanol as an alternative energy source.

Biology

There are three main varieties of edible kelp in the Northeast: the sugar kelp, *Saccharina latissima*, the horsetail kelp, *Laminaria digitata* and the winged kelp, *Alaria esculenta*. Kelps are subtidal (also called sub-littoral) seaweeds, unable to withstand any long-term exposure to air or desiccation, though they can be occasionally be partially exposed during extreme low water events. *Saccharina latissima* has the widest geographical distribution of the three species in the Northeast US, and can be found growing from Maine to western Long Island Sound. *Laminaria digitata* and *Alaria esculenta* are typically found north of Cape Cod.

Kelps can inhabit the upper, mid, or lower sub-littoral zones down to depths of up to 50 meters, given sufficient light penetration (down to approximately 5% of the surface light intensity). They are able to withstand strong currents and high-energy environments with a branched holdfast structure, which superficially resembles the root structure of a land plant, but functions only to secure the plant. It does not participate in significant uptake of water or nutrients. A strong and flexible cylindrical stipe, resembling in form the stems or trunks of land plants, allows the blades to move with waves and currents and lay flat in the water during very low tides. Morphologically plastic and flexible blades take up necessary nutrients from the water, and are able to transport nutrients and the products of photosynthesis up and down the length of the blade. New growth of the blade primarily occurs at the base of the blade, directly above the stipe, an area called the intercalary meristem (Figure 3.2). This allows for the top, or apex, of the blade, to be regularly shed, which helps clear old or fouled tissue.



Figure 3.2. Parts of the sugar kelp (*Saccharina latissima*).

The three varieties of kelp differ in blade morphology (Figure 3.3). *Laminaria digitata* and *Saccharina latissima*, both of the family Laminariaceae, have thick, smooth, leather-like blades and produce reproductive tissue on the blade. *S. latissima* has a single, undivided, and morphologically plastic blade that will adapt to differing wave energy environments. The blade can be ruffled at the edges to optimize current flow and nutrient delivery in low energy environments, or can be smooth and narrow in order to minimize drag in high-energy environments (Gerard and Mann, 1979; Fowler-Walker *et al.* 2006). *Laminaria digitata* has a wide blade that splits into narrow straps, which is an adaption to high-energy environments. *Alaria esculenta* (family Alariaceae) has a fibrous holdfast and single blade around a central midrib running the length of the blade. Reproductive tissue is produced on separate blades that grow horizontally from the midrib, just below the main blade. Despite morphological differences between the three types of kelp, they all have a similar two-part life cycle.

Kelps, like all seaweeds, have a seasonal cycle of growth and reproduction. The combined influences of light, photoperiod, and temperature affect and control kelp growth and development (Lüning, 1990). Kelp has a winter growing season that extends from fall to spring, with much of the growth occurring in spring with increasing temperatures and light levels. The growing temperature range for Northeast American kelp is from 5-20°C, with optimum temperatures between 10-15°C (Egan and Yarish, 1990). While temperature is the most important condition regulating kelp distribution and growth, presence of solid substrata (a rocky coast), sufficient water current, light, near full strength salinities, and nutrient availability are also very important factors (Egan and Yarish, 1988).

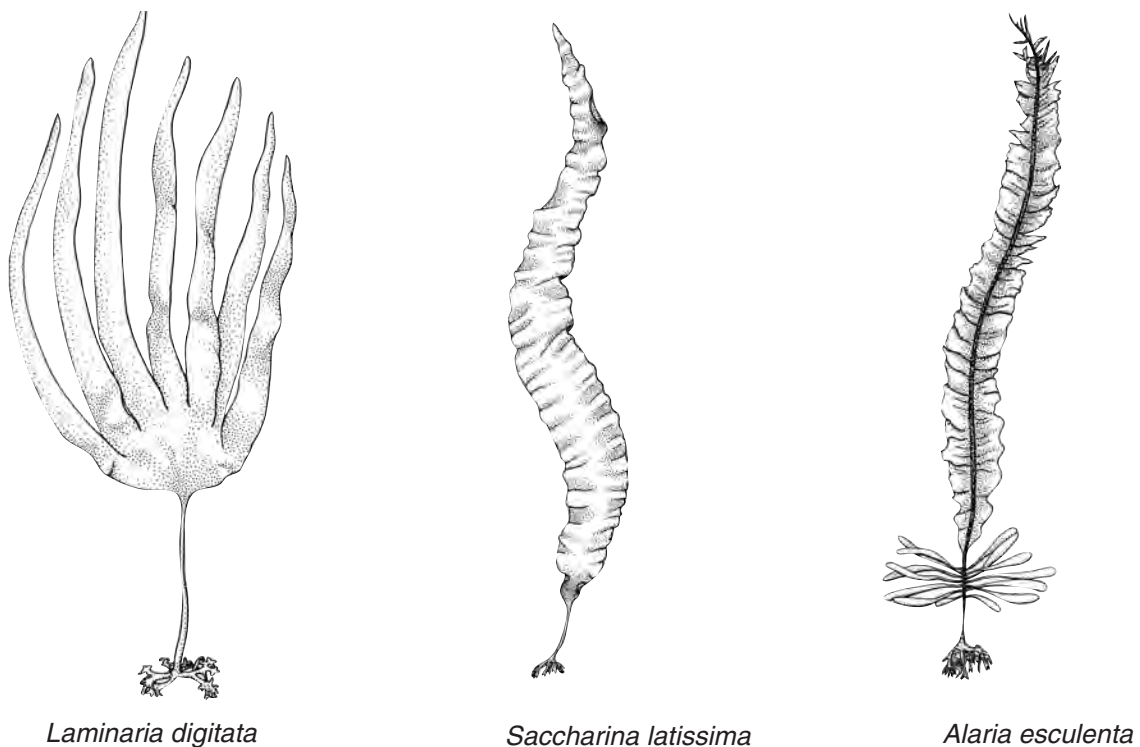

Figure 3.3. Kelps of the Northeast.

All kelps have a two-part life cycle, called a heteromorphic life cycle, consisting of a large visible stage (called the sporophyte phase), and a microscopic stage (called the gametophyte phase) (Figure 3.4).

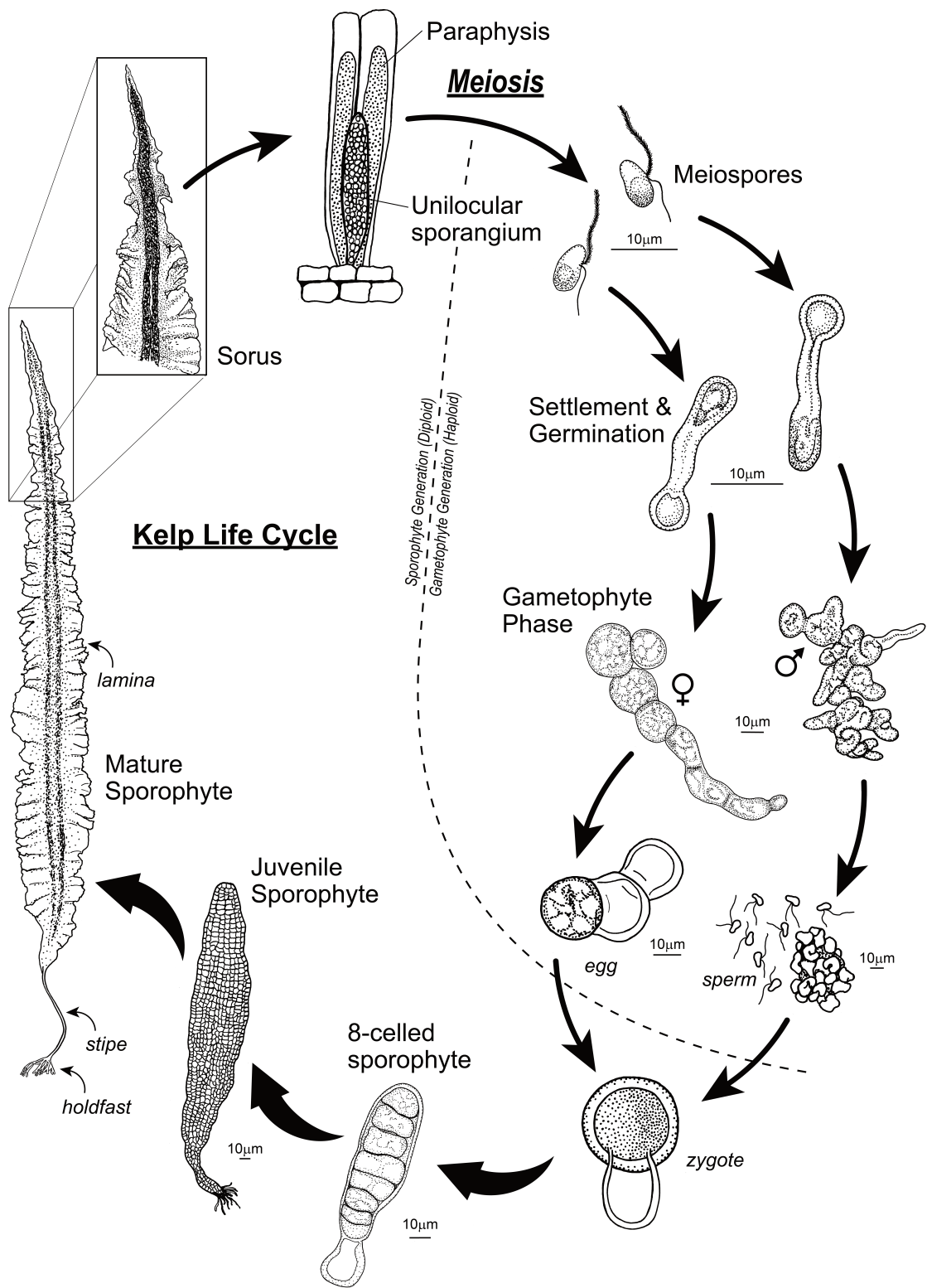

Illustration by Virge Kask, 2012 © Charles Yarish

Figure 3.4. The kelp life cycle

The large fronds that are found in subtidal zones are called sporophytes, because when they are mature, a reproductive section of their blade (sorus tissue) will produce and release microscopic spores into the water column (Van Patten and Yarish, 1993). Sorus tissue is apparent as a darkened, thickened portion that forms on the blade (*Saccharina* and *Laminaria*), or just below the blade (sporophylls in *Alaria*). Spore producing cells within the sorus tissue undergo meiosis to produce genetically distinct spores. When mature, sorus tissue will release billions of haploid, bi-flagellated meiospores (sometimes called zoospores) that have a limited capacity to swim and photosynthesize, but usually settle within 48 hours. Settled spores will adhere to a substratum, shed their flagella, and initiate the formation of the microscopic stage. This is known as the gametophyte stage because the spores will develop into microscopic male or female gametophytes, which represents the sexual phase.

Gametophyte development occurs in several stages and is controlled by environmental variables including light, photoperiod, nutrient availability, and water temperature. The attached meiospore develops a germ tube and pushes all of the contents of the original spore into the first cell, called the primary cell. This stage occurs usually within 48 hours of settlement, and is known as the ‘dumb-bell stage’. The vegetative growth phase then increases the primary cell size and new cells are added to form microscopic filaments that can be anywhere from 1-3 cells to hundreds of cells in size. Gametophytes are dioecious, which means that male and female filaments develop separately and are distinguishable under a microscope by differences in size and morphology. Female gametophytes are comprised of larger more robust cells and the filaments are less branched than males. It is usually possible to distinguish males from females after the first or second week of culture.

Under favorable environmental conditions, gametophytes mature and the reproductive phase will produce oogonia and antheridia potentially in any cell of the separate female and male gametophytes, respectively. A single egg is extruded from each mature female oogonium along with the hormone lamoxirene, which signals release and attraction of the flagellated spermatozooids from nearby males (Lüning, 1990). After the egg is fertilized, the diploid zygote divides longitudinally to develop into the small juvenile sporophyte, usually developing directly on the female gametophyte. Small rhizoids are produced basally as the blade expands, and these will develop into the holdfast that anchors the blade to the substrate.

An understanding of the kelp life cycle is essential for manipulating the life stages in the laboratory. In the lab, meiospores are released from sorus tissue, settled onto ‘seed string’, and then proceed to develop into male and female gametophytes attached to the fibers of the string. When gametophytes mature, fertilization of extruded eggs will take place on female gametophytes, and the resulting zygotes will then develop into juvenile diploid sporophyte blades. Once the juvenile sporophytes are approximately 1-2mm in length, the seed string can be out-planted on horizontal long lines in the sea for further development of the large adult sporophyte.

Cultivation

Seawater

The microscopic phase of kelp should be cultivated in clean, sterile, natural seawater collected from an area free of any terrestrial runoff, with a salinity between 28 and 34 ppt. Seawater should initially be filtered through a rough sand or cartridge filter at the time of collection, and passed through a series of finer filters to remove microscopic organisms.

Once filtered, seawater should be sterilized. While it is not necessary to have axenic cultures to grow kelp, the microscopic phases are sensitive to contamination, so it is important to have clean seawater to work with. There are a host of microorganisms that can feed on, compete with, or overgrow the gametophytes, including other algae, fungi, bacteria, and protozoa. Protozoan grazers can especially be a problem at high concentrations. While it is difficult to eliminate all contaminants, it is essential to keep contamination at a minimum, below levels that would inhibit or disable growth of gametophytes or juvenile sporophytes. The most effective way to do this is to eliminate the problem at the source. If sterilized seawater is being used, then the cleaning of the sorus tissue before spore release will be the most important step of the culture process.

Nutrient Media

After sterilization, half strength Provasoli's Enrichment Solution (PES) must be added to the seawater (see Appendix). This solution is made up in mass quantities beforehand, filter sterilized, and refrigerated until ready to use. It is added at 10 milliliters per liter of water (this is half-strength, the preferred concentration for kelp). Instructions for preparation of this media can be found in the Appendix. Seawater must be changed once per week during the culture period, and this can be set up as a simple operation that involves transferring cultures from one tank to another with fresh seawater media.

Culture System

The most important aspect to a kelp culture system is sufficient temperature control. Water temperature must be maintained within the 10-15°C range throughout the culture period. This can be done by placing culture tanks within a temperature controlled room or chamber, or by controlling the temperature of the seawater within the culture tank. In the absence of an environmental chamber, a relatively simple culture system can be built using an aquarium chiller. This system includes two tanks (to alternate each week for weekly water changes), a chiller for temperature control, and aeration (Figure 3.5). Common household fish tanks (10 or 20 gallon) can be used, or custom clear Plexiglas tanks can be built. A high quality aquarium chiller is sufficient to maintain the growing tank temperature within 1 or 2 degrees of 10°C, though it is important that the culture room is relatively cool (below 30°C) to avoid overstressing the chiller. A chiller requires an external pump to circulate the water, and a simple plumbing system should be erected that allows one tank to be utilized at a time, with the capacity to switch tanks each week for water changes. Another separate pumping system is useful for emptying the tanks each week during water changes. Aeration is important for current generation, gas exchange, and maintenance of pH levels, especially when young sporophytes begin to develop. Aeration can be provided with a simple aquarium air pump or with a larger blower-based system. Either way, air entering the system should be filtered and free of any contaminants.

Blades are cultured on PVC spools (usually 2") placed upright in the tanks. Seed spools are prepared by winding 'seed string' around PVC pipes cut to the length of the culture tank. Notches in each end of the PVC spool will hold the ends of the string. It is useful to leave a few millimeters of excess string at the ends of the spool for monitoring, or to put in a few knots with loose ends in the spooling of the string. These loose ends can be cut and pulled apart in order to observe individual filaments under the microscope to monitor the growth and development of the gametophytes and young sporophytes. Seed string is specially made in China,

Korea, and Japan for the specific purpose of cultivating kelp, but any type of synthetic twine (nylon twine, or a nylon/cotton blend) may be used for cultivation of kelp. A trial and error approach may be necessary to find the best type of seed string for the grower. It is essential that the string be clean, chemically untreated, and hydrophilic. String should not be wound too tight, as gametophytes need to settle and develop on the individual string filaments. Seed string should always be handled with latex gloves in clean environments to prevent skin oils from inhibiting settlement of spores or any possible contamination. After the string is wound on clean, pre-soaked PVC pipes, it should be soaked for a few hours in either sterilized deionized water or sterilized seawater before inoculation. If the string has been

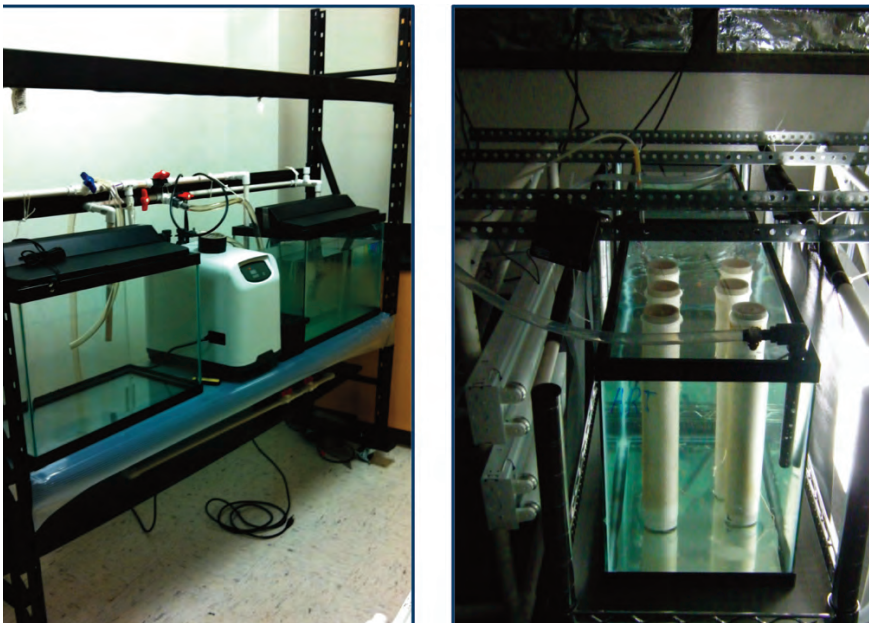

Figure 3.5. Kelp culture systems including position of PVC spools in tanks with light and circulators.

handled and needs to be cleansed, it can be soaked in a solution of sodium chloride (50-100g per 5 gallons) then rinsed several times to remove surface oils.

Light (High output cool white T-12 florescent bulbs) can be supplied from the sides of glass tanks from fixtures mounted horizontally on simple light racks (Figure 3.6), placed on both sides. Two light fixtures containing two bulbs apiece on each side will span the height of the tanks and provide evenly distributed light to the spools. Lights should be on timers to automatically shut off at night, and intensity can be controlled with layers of screening, or by adjusting the distance of the lights from the tanks. In order to ensure even lighting during culture, spools should be rotated on a regular basis order to expose all sides of the spool to sufficient light.

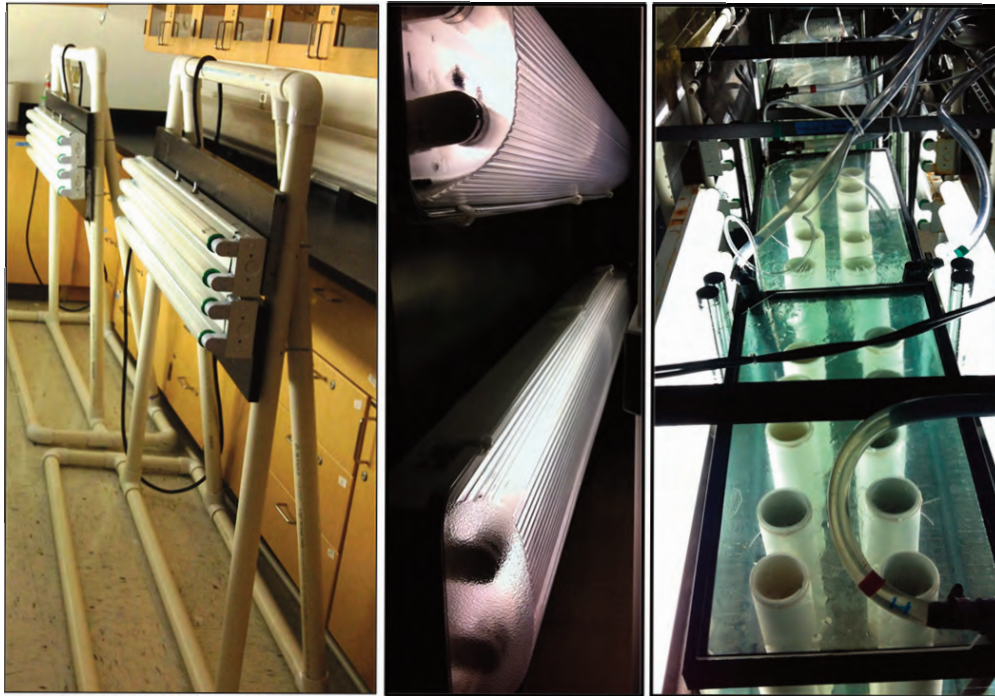

Figure 3.6. Lateral or side lighting for kelp culture systems.

Culture Initiation

Kelp culture consists of three main steps—inoculation, lab culture, and field culture. There are two ways to inoculate, or “seed” culture string for sporophyte production. The first method directly seeds wild-collected spores onto seed string, while the second method produces young blades using lab-raised fragmented gametophytes. The first ensures a high density, consistent set on the seed string, but does not allow for genetic control, and wild harvested reproductive material can be difficult to obtain, with a higher risk of contamination. The second method, sometimes called the “European method”, requires additional lab space and care for maintenance of the cultures, but allows for genetic control and crossing of plants with desirable characteristics, and ensures a reliable source of seed throughout the year.

Wild-sourced seed

To obtain spores for seeding, reproductive sorus tissue from wild plants must be carefully collected and processed in the laboratory. Reproductive plants can be found throughout the year, though the primary reproductive periods occur in the spring and autumn months (Egan and Yarish, 1990; van Patten, 1992). Mature sorus tissue can produce billions of spores per plant; so sufficient spore numbers for seeding can be acquired from just a few ripe plants from the wild. Problems associated with wild harvest of mature plants include difficulties involved with subtidal collection, contamination, and lack of genetic control.

Kelps are subtidal, so they need to be collected by SCUBA, snorkeling, or at extreme low tides. Sorus tissue can be clearly seen as a dark band on the blade of the plant (Figure 3.7), ranging from about 5% - 90% of the total surface area of the blade. It is important to handle the blades carefully and process the sorus tissue as soon as possible. Sorus tissue can be cut from whole plants, leaving the bottom portion of the plants intact to regrow. Healthy, clean plants, free of any obvious epiphytes or epibionts, should be selected to minimize the risk of contamination from the presence of biofouling organisms. Sorus tissue should be kept cool and moist, out of direct sunlight, wind, or extreme temperatures. Plants can be transported in seawater or between moist paper towels back to the lab to be processed.

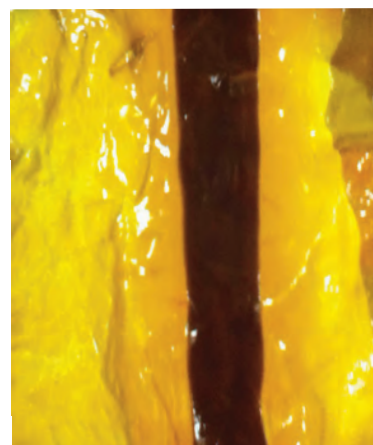

Figure 3.7. Sorus tissue on *S. latissima*.

Processing Wild-Collected Material

Sorus tissue can introduce microscopic contaminants into the spore solution and then into the culture, and these can overgrow or overgraze the microscopic plants, resulting in a weak or unsuccessful culture. The most important step in kelp culture is the cleaning process. To clean collected sorus tissue, a clean working area should be set up with a cutting board, several shallow trays with sterilized seawater (10°C), a seawater squirt bottle, and paper towels. The cleaning process involves a series of rinses and wipes in order to remove microscopic contaminants on the surface of the blade. Sorus tissue should be excised from all non-reproductive tissue, and cut into manageable strips. Both sides should be carefully and gently scraped with the edge of a clean razor blade or other straightedge. This is followed by a series of rinsing and wiping down of the blades in the shallow trays and wiping with clean paper towels, with a final rinse on both sides with the squirt bottle (Figure.3. 8).

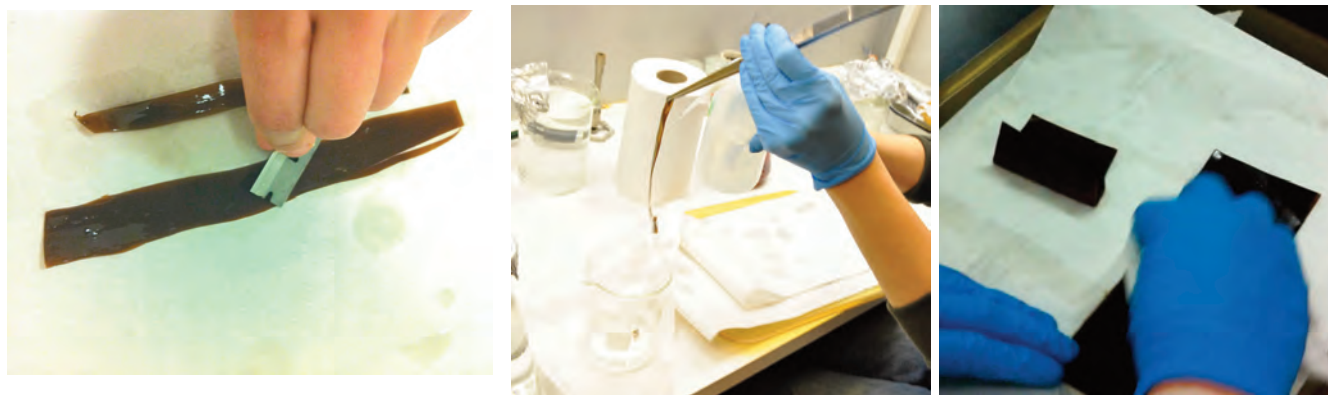
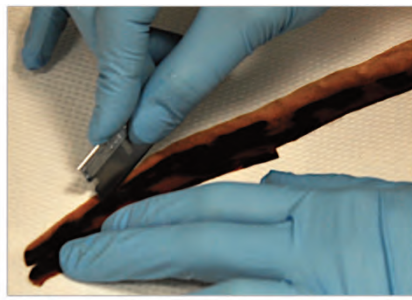

Figure 3.8. Sorus tissue cleaning process: 1) gently scrape surface with a clean flat edge; 2) rinse with sterile seawater; 3) wipe down with clean paper towels; & 4) repeat rinsing and wiping steps 2 and 3 several times.

If there is a concern about introducing unwanted contaminants, you can use an iodine dip as part of the sorus cleansing process. This can be achieved by soaking clean sorus tissue in an iodine bath for 30 seconds (using a Betadine® solution at 5 mL/L sterilized seawater at 10°C), rinsing, then soaking in clean seawater for 5-10 minutes, and wiping again with a clean paper towel.

After cleaning, the sorus tissue is placed between clean paper towels and refrigerated overnight at 10°C in a Ziploc® bag. The paper towels should be damp with sterile seawater, but not too saturated. This step allows the sorus tissue to undergo a gentle desiccation period in order to stimulate spore release with re-immersion in seawater (Figure 3.9).



Trim and clean sorus tissue.



Desiccation period in damp paper towel.



Re-immerses in seawater.



Strain spore solution.

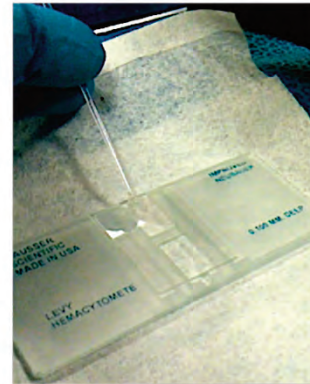

Determine and adjust spore density for inoculation.

Figure 3.9. Sorus tissue preparation and spore release.

Inoculation

After a sufficient desiccation period (around 10-20 hours but before 24 hours), spores are released by re-immersing tissue in sterilized 10-15°C seawater. Several strips of sorus tissue can be immersed in 1 or 2-liter clean beakers or flasks for spore release, which will be apparent as a cloudy release in the water. Spore release can occur immediately, or can occur over a period of several hours (Figure 3.10). To determine spore density, the solution is stirred up with a pipette, and a sample is observed using a haemocytometer under a compound microscope (see Appendix). It is recommended that seed string be inoculated at a density of 1,000-5,000 spores per mL, though with a successful seeding, 2,000 spores per mL results in very dense cultures as the plants grow, so this is an important component that can be adjusted to the needs of the grower (see Appendix for information on density determination).

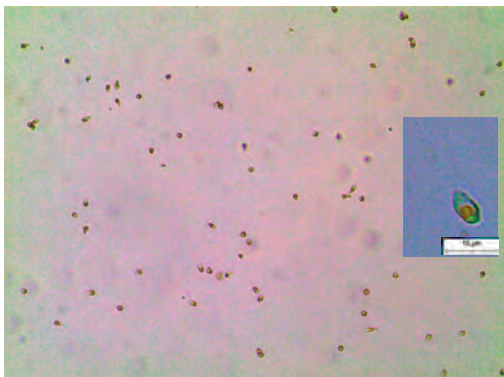

Figure 3.10. Background: successful meiospore release. Foreground: closeup of flagellated kelp meiospore.

After determining the density of the spore solution, prepared seed spools are inoculated with the swimming spores. Spools can be inoculated in any type of bucket or container that allows spools to be completely submerged in sterilized 10°C seawater. Very gentle aeration will provide mixing for even distribution, and the container should be covered and left for 24 hours to allow the spores to settle and adhere to the seed string. After the 24-hour inoculation period, spools are removed from the inoculation container and placed in clean sterilized seawater tanks with half strength PES media and germanium dioxide added. Glass slides can be inoculated at the same time as the spools, and cultured under the same conditions. This will allow for observation and monitoring of the development of gametophytes and sporophytes under the microscope.

The first week of cultivation requires light aeration, light intensities of 20-30 $\mu\text{mol photons m}^{-2}\text{s}^{-1}$, and temperatures of 10-15°C. After the spores settle onto the seed string, they will begin developing into male and female gametophytes. The attached spore puts forth a germ tube and pushes its contents into the primary cell (Figure 3.11). This is considered the 'dumb-bell' stage. The primary cell rounds off, enlarges, and proceeds to develop into either a male or a female gametophyte. Growth and development can be observed by inspecting individual strands of string or glass slides under the microscope. Under optimal environmental conditions, gametophytes will increase in cell number, developing into short, branched filaments of variable cell number for the first two weeks, then start becoming reproductive after three and four weeks. Female gametophytes have larger cells and are less branched, and male cells are smaller in diameter but often have extensive branching.

Spools should be transferred to clean sterilized seawater with fresh half strength PES and germanium dioxide (=GeO₂) the second week of culture. This should be a quick and easy transfer of spools from one tank to another tank of prepared seawater

Spore Release and Inoculation Checklist	
	Clean work area (alcohol spray bottle to sterilize surfaces)
	Sterile seawater (10°C) for release and inoculation
	Refrigerator or ice bath to maintain water temperatures below 15°C
	Cheesecloth or PVC filter tubes for straining spore solution
	Clean pipettes for stirring spore solution and removing samples
	Haemocytometer, compound microscope and calculator for density determination
	Beaker or graduated cylinder for measuring out spore solution for inoculation
	Prepared seed spools ready for inoculation
	Inoculation container (bucket, tube) with temperature control and light aeration for overnight inoculation

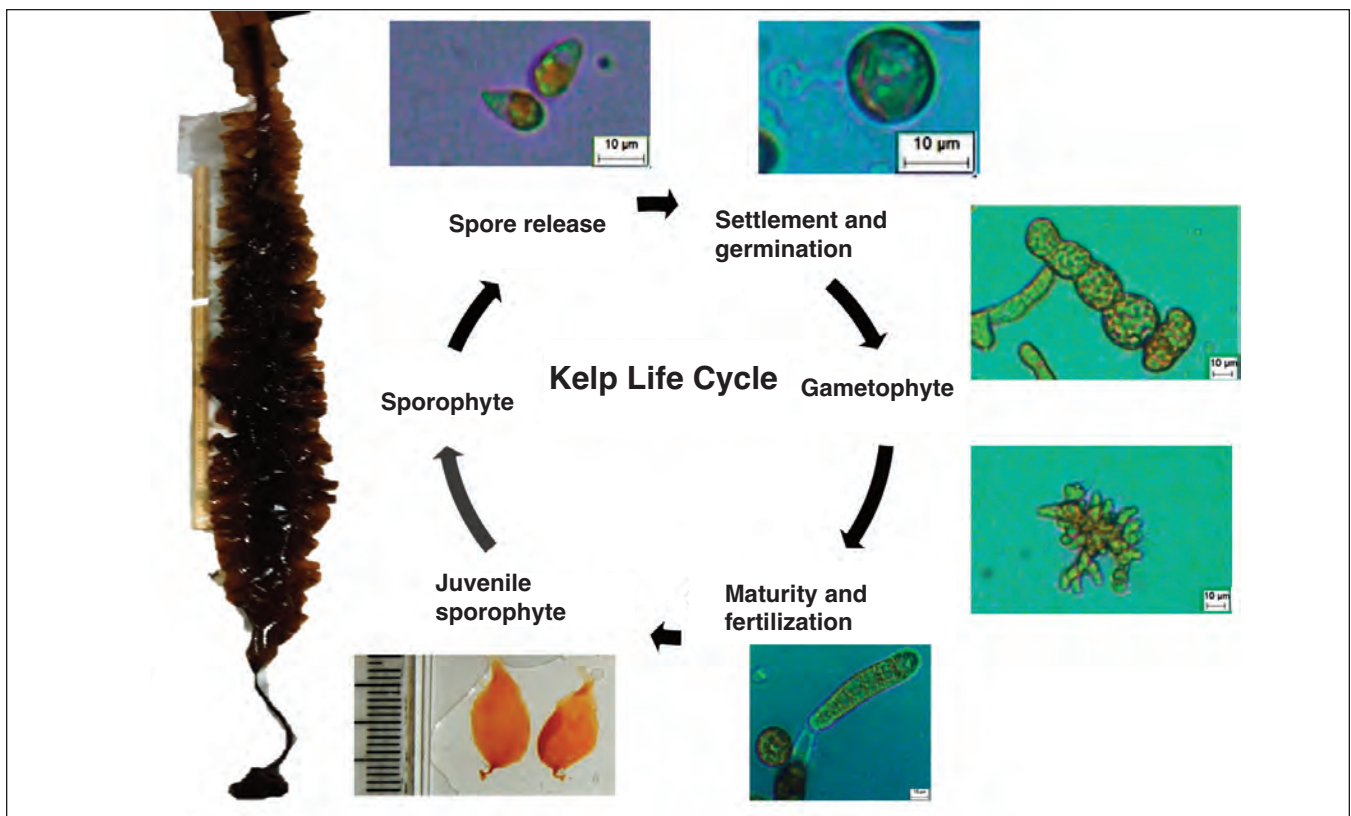

Figure 3.11. Kelp life history stages.

of the same water temperature. Spools should be transferred once per week in this manner, though the use of GeO_2 can be eliminated if there are no signs of diatoms after the second week. Each week the light levels can be increased, from 20-30 $\mu\text{mol photons m}^{-2}\text{s}^{-1}$ the first week, to 40-50 $\mu\text{mol photons m}^{-2}\text{s}^{-1}$ the second week, 50-60 $\mu\text{mol photons m}^{-2}\text{s}^{-1}$ the third week, and 60-70 $\mu\text{mol photons m}^{-2}\text{s}^{-1}$ during the fourth week of culture. It is important to maintain aeration during the culture period to ensure sufficient nutrient supply to all blades as well as to maintain pH as the blades increase in size and photosynthetic activity. Juvenile sporophytes are usually formed during the second and third week, and can be seen on the string as a brown 'fuzz' (Figure 3.12). Plants should be about 1 mm by the fourth week and could be ready to out-plant into the field.



Figure 3.12. Kelp grown on seed string wrapped around PVC spools left spools initially after inoculation; middle set of spools about 14-21 days after inoculation; and right spools about 28-35 days after inoculation.

Field culture

Juvenile sporophytes can be out-planted when plants are 1-2 mm in length (Figure 3.13). Seed spools should be carefully handled during transport and planting to protect the small blades from stress or exposure. Spools can be moved in small, sealed containers in 10°C seawater, minimizing exposure and movement. Transfer tubes can be built for this purpose with a large diameter plastic pipe with a cap glued at one end and another cap at the other end for a cover. If building a transfer tube, provide adequate time to soak these tubes to prevent problems with the resin glues that may be present. If no tube is available, plastic bags filled with seawater and placed in a rigid box can hold individual tubes for transfer, taking care to keep the spools from moving around too much to avoid losing blades. Blades are sensitive to exposure and should be protected from sunlight, freezing, or drying during transplanting.

Grow-out systems are simple horizontal long line systems placed at some depth below the surface of the water that will provide sufficient amount of sunlight to the growing kelp blades, especially during the winter months. Ideal depth may change depending on light availability and water clarity, and lines could be adjustable to optimize growth (Figure 3.14). Seeding of long line is a simple procedure wherein the line is threaded through the PVC seed spool, and seed string is 'spooled off' in a spiral fashion onto the line. Optimal depth placement of the long lines will depend on the growth site, water clarity, and season, but recommended depth placement is at 1-2 meters. Once out-planted, blades require little attention. The longline system should be checked on a regular basis to ensure that there is no loss or damage from storms, vandalism, or passing boats. If blades are too crowded, thinning of the lines may be required.

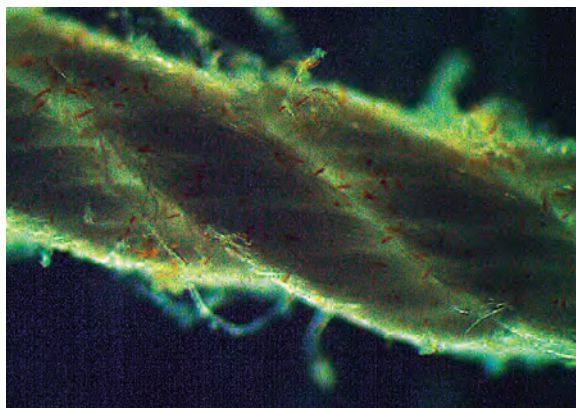

Figure 3.13. Close-up of seed string with juvenile sporophytes.

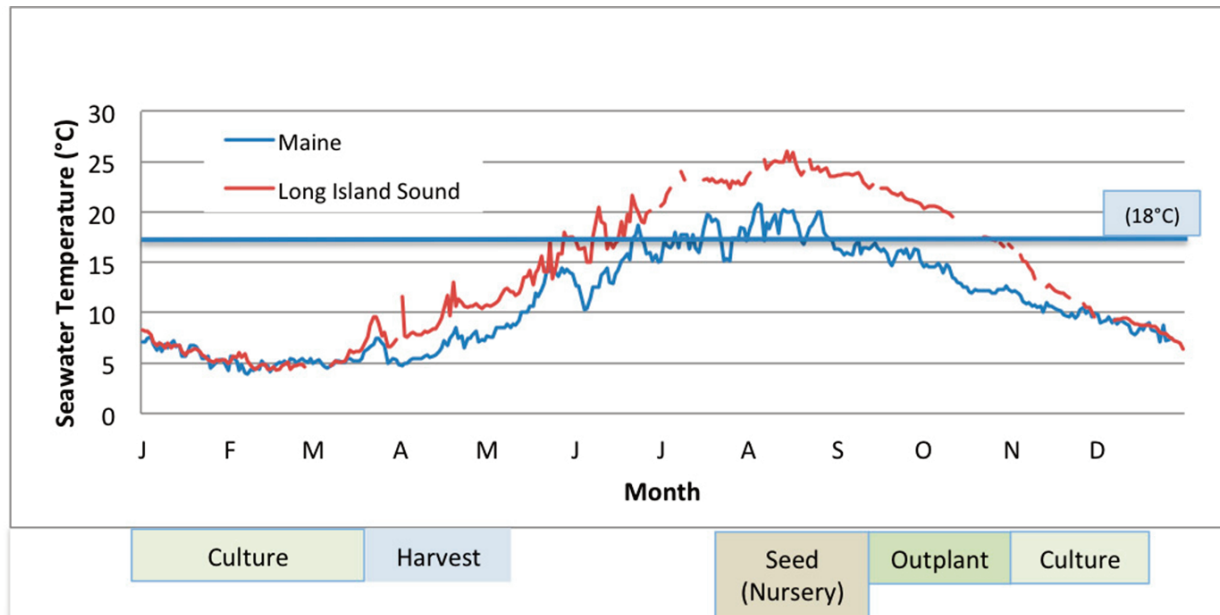

Figure 3.14. Culture plan for the kelp growing season (data from <http://neracoos.org>).

Isolation and Maintenance of Vegetative Cultures

Also known as the “European method”, vegetative culture is an alternative way to produce young juvenile kelp blades in the lab. This method isolates individual gametophytes until ready for use. Keeping a laboratory seed stock ensures a supply of gametophytes for seeding, allows for breeding of select blades, and provides a clean seed stock free of contamination. This requires environmentally controlled laboratory space for long-term maintenance of the cultures. The overall technique involves an initial wild collection of sorus tissue, isolation of individual gametophytes, vegetative clonal culture under red light, and then fragmenting and mixing males and females for the production of juvenile sporophytes.

To initiate vegetative culture, reproductive sorus tissue must be collected from the wild to obtain spores. The best time to collect blades from the wild for the development of a genetic library or breeding program is in the spring, when the blades are exhibiting their growth peak and most are reproductive. Blades with desirable characteristics should be chosen for isolation, and measurements of the blade (stipe length, blade length and width) should be recorded for any breeding work that might be done. A photograph of the parent blade might also be useful, as well as the preparation of a herbarium sheet. Processing of sorus tissue is the same as described above. Mature sorus should be excised, rinsed and wiped clean, and stored overnight at 10°C in darkness. It is essential that sorus be especially clean for isolation. When spores are released in sterile seawater the following day, spore solution can be added to Petri dishes containing clean glass slides and allowed to settle at 10°C for 24 hours. After the spores have settled, slides should be removed, rinsed with sterilized seawater, and placed in clean petri dishes with half strength Provasoli’s Enrichment Medium (10mL PES/L natural seawater; Provasoli, 1968). The dishes should be sealed with Parafilm® to prevent evaporation. Gametophytes are then cultured under red light (30-60 $\mu\text{mol photons m}^{-2} \text{s}^{-1}$ light intensity) for approximately two weeks until male and female filaments can be easily distinguished under a microscope. Red light can be provided by red bulbs or by placing gametophytes under red plastic. Blue light (provided in sufficient quantities by regular white fluorescent

light) is required for gametogenesis and reproduction (Lüning and Dring, 1972), so culturing gametophytes under red light allows for vegetative growth of the gametophytes.

After 10-14 days, gametophytes can be isolated using a fine-tipped Pasteur pipette and a microscope. Pipettes can be prepared in the laboratory using an open flame and forceps. Wearing goggles for safety, the tip of a Pasteur pipette is held with forceps over a flame until the glass is soft, at which time the tip is pulled out and then snapped off to create a small bore for isolating individual gametophytes. Individual male and female gametophytes are isolated under a microscope with prepared pipettes and placed in a small vials or petri dishes with half strength PES. Isolated filaments made up of just a few cells can then be grown into large clonal masses wherein each cell is genetically identical. If cultures are only being maintained, the isolates can be cultured with no aeration in sealed vials or dishes under red light (Figure 3.15). Gametophytes will grow vegetatively into filamentous masses, observable over time as a brown fuzzy mass (Figure 3.12). Cultures may be maintained in this manner indefinitely, requiring only occasional media changes (Table 3.1).

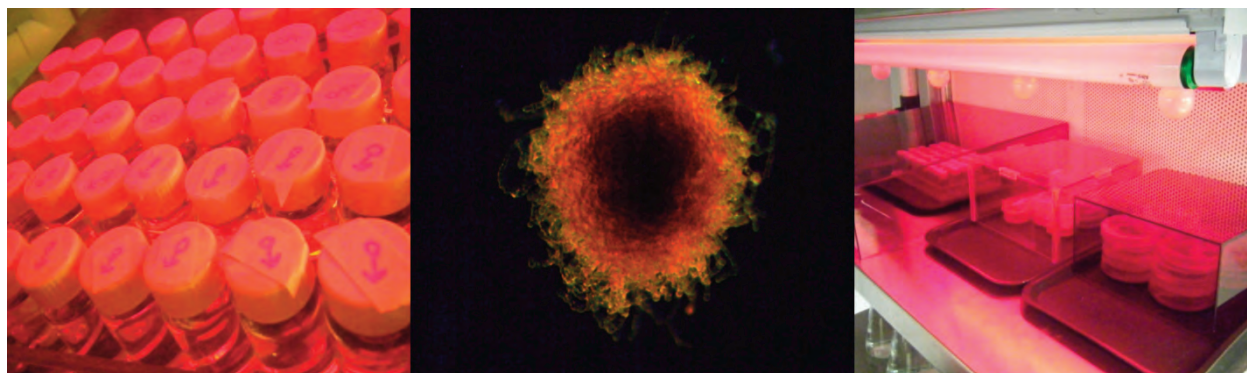

Figure 3.15. Vegetative culture of kelp under red light for gametophyte maintenance.

To increase clonal mass of cultures in preparation of seeding, the vegetative masses can be separated into individual filaments using a Teflon®-glass pestle homogenizer or a blender, and these smaller filaments can then be grown into new masses. Growth rates will increase if fragments are exposed to higher intensity red light or placed under white light, placed in a larger culture vessel, and cultured with aeration. Each fragment will continue to grow vegetatively, and cultures can be grown and re-fragmented until sufficient mass is produced for seeding. To produce plants, males and females are fragmented in a blender to produce small (1-3 cell) fragments and mixed together in a 3:1 male: female ratio. A small blender with thin, sharp blades will be most efficient at creating small fragments. Smaller fragments allow for less clumping of cells and a more even distribution of blades on the seed string, as each female cell can potentially produce an egg, and larger fragments will result in clumping of plants. After fragmenting, gametophytes can be passed through a 35 μm Nitex® filter in order to isolate fragments of one size class. This allows for more control and consistency in seeding.

Once males and females are mixed, the gametophyte solution is carefully sprayed onto the string surface for seeding (Figure 3.16). To use the PVC seed spool technique, the seed spools can be placed vertically in a shallow dish, and the solution sprayed evenly onto dry seed string. Once inoculated, spools are gently placed into undisturbed seawater for approximately 48 hours to allow attachment to the seed string before applying gentle aeration. While inoculating seed string, gametophytes are exposed to white light to stimulate gametogenesis (egg and sperm production and release) for the production of juvenile sporophytes. During this time, the fragments will adhere to the surface, form zygotes (fertilized eggs), and young juvenile sporophytes will begin to develop. A very gentle aeration should be provided to allow for gas exchange, but not enough to detach the blades. After spools are inoculated, they can be cultured in half strength PES media in tanks in the same manner as described above. Young blades can be ready for transplanting (1-2mm length) in about two weeks using this method. However, trials using this technique for seeding seed string indicate poor retention of juveniles once planted out in the sea. While gametophyte fragments have the ability to secrete an adhesive substance to adhere to the seedstring, the attachment is not as effective as plants that are seeded from spore. For this reason, more work needs to be done to develop this technique in order to produce consistent seeded line.

Table 3.1. Kelp culture conditions for gametophyte and sporophyte culture systems.

Optimal Environmental Conditions:	Gametophyte Phase		Sporophyte Phase	Culture Equipment
	Release & Settlement of Meiospores	Optimal Growth & Sporophyte Formation	Juvenile Sporophytes	
In general, for all months	Release & Settlement of Meiospores	Optimal Growth & Sporophyte Formation	Juvenile Sporophytes	Individual rectangular glass aquaria fitted with 2" PVC seed string (cotton/nylon blend)
• Temperature (°C)	10-20	10-15	10-15	Recirculating saltwater aquarium chiller units
• Light fluence ($\mu\text{mol photons m}^{-1} \text{s}^{-1}$)	0-25	5-60	25-150	High output cool white fluorescent lights 24-hour programmable light timers
• Photoperiod	12:12 L:D	12:12 L:D	12:12 L:D	
• Seawater salinity • Seawater source	30-32 Natural	30-32 Natural	30-32 Natural	Sterilized seawater: autoclaved, Micro filtered, or inline UV light
• Nutrient media	Provasoli's Enrichment Media (PES), ½ strength	PES ½ strength	PES ½ strength	
• Diatom Control	Germanium Dioxide	Germanium Dioxide	Not needed if culture is clean	Available for order from laboratory supply companies
• Aeration levels	Very low	Medium	Medium	Air should be filtered to avoid contamination



Vegetative gametophyte cultures

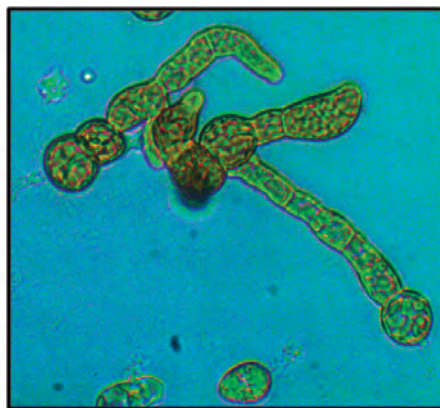

Vegetative female gametophytes



Juvenile sporophyte on seed string

Figure 3.16. Seeding with vegetative cultures.

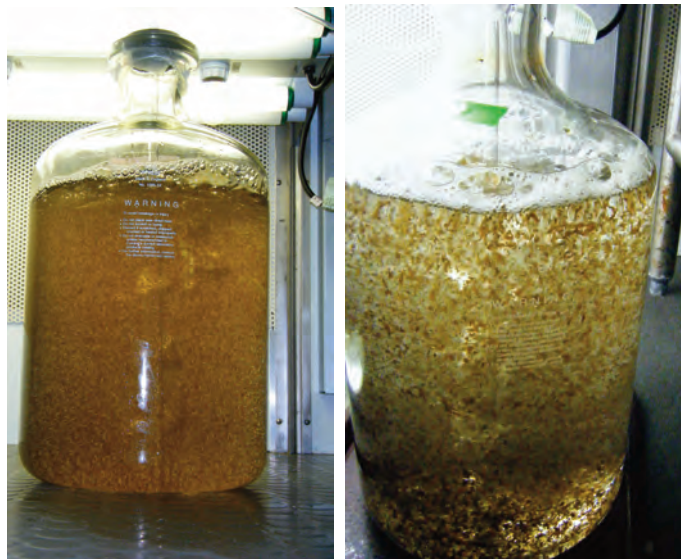

Figure 3.17. Tumble culture of juvenile sporophytes in aerated Pyrex® jars.

This cloning technique allows for greater control over sporophyte production. Sporophytes can be produced at any time of the year, and the risk of contamination of the young blades is eliminated. Gametophyte cloning from single strains also allows for genetic manipulation of new blades, and crop improvement is possible through breeding and selection of blades with superior qualities. To cultivate blades for breeding, selected gametophytes are mixed, exposed to white light, and tumble cultured until blades are large enough to manually attach to long lines. Manually attached blades allow for greater control over density on the line to minimize problems of overcrowding and shading.

Tumble Culture

Tumble culture is another method of laboratory plant production (Figure 3.17). This method can produce large numbers of free-floating blades in large glass carboys or tanks, which can be manually attached to long lines for further grow-out (Figure 3.18). Cultures can be initiated from vegetative cultures by fragmenting vegetative filaments, combining males and females at a 3:1 ratio, and culturing under white light with aeration. The



Figure 3.18. Manually attached kelp produced in tumble culture, used for growth measurements.

mixed gametophytes will become reproductive under white light and produce juvenile sporophytes, which can then be cultured in large 13-20L carboys under the same conditions as described for seeded lines. Another way to obtain free floating kelp blades is from seeded cultures, where a great number of detached sporophytes normally lost during the weekly culture changes can be collected and tumble cultured. This culture type allows for long-term maintenance of young sporophytes, with very slow growth of the blades at high densities and low light intensities. For culture maintenance, half strength PES media can be changed every 7-14 days. To increase growth rates, density is decreased, light is increased, and the media is changed more frequently (1-2 times per week). This method could be another way to maintain stock cultures in the laboratory, providing a backup supply of blades, and could also be a means of selecting the fastest growing blades in a mixed culture (Table 3.1, page 28). Tumble culture can be used in breeding projects, where blades from controlled gametophyte crosses can be manually attached to lines at a consistent density for grow-out experiments in the field.

Chapter 4. *Gracilaria*

Gracilaria tikvahiae

Gracilaria tikvahiae is the only *Gracilaria* species native to New England (Figure 4.1). The genus *Gracilaria*, in the Phylum Rhodophyta (a group of the red seaweeds), contains over 100 species found around the world, and many are wild harvested and cultivated for food, animal feed, and the phycocolloid called agar. They are warm water seaweeds, usually preferring temperatures in the 15-30°C range, making them a potential summer species for culture in New England. *Gracilaria* is an ideal candidate for aquaculture due to its warm-water growing season, ease of propagation, relatively high growth rates, high tolerance to a range of environmental conditions, and its existing and potential commercial value.

Biology

Gracilaria tikvahiae has a variable morphology, which depends on the strain and growing conditions. It is a bushy, branching seaweed, comprised of rounded branches which are irregularly or dichotomously branched from rounded, compressed, or flattened axes (Figure 4.2). Blades are usually red, but can be brownish, green, or almost black depending on light and nutrient conditions. Blades arise from a flattened disc that is formed from a spore. Growth occurs by an apical meristem, located at the tip of each branch. Blades can reproduce through spores or by vegetative propagation, and can be found as either attached or free floating in coastal areas.

Gracilaria tikvahiae is a species that has a wide range of tolerance for changing environmental conditions. It is common in estuaries or bays, often found in intertidal or shallow subtidal areas, less than 1 meter deep, either attached to rocks or free floating. It is often found in embayments, which are environments with reduced water flow and may be rich in ammonia and nitrate. They are a euryhaline species, which means they can tolerate a wide range of salinities, from about 10-40 ppt, though they grow best in ranges of 25-33ppt. They can survive temperature ranges from 0-35°C but have an optimal range of 20-28°C.

Gracilaria has a three-stage life history that is similar to many other red seaweeds, often called a Polysiphonia-type life history (Figure 4.3). It has an isomorphic (“same shape”) alternation of generations. This indicates that two of its three life stages, the tetrasporophyte and the gametophyte stage, are morphologically identical. The life cycle has three different stages; a diploid tetrasporophyte stage, a haploid gametophyte phase, and a diploid carposporophyte phase that occurs on the female blades. These stages are distinguishable only by microscopic examination of the reproductive structures or presence of the third stage, which appear as bumps on the branches of the female blade. The mature diploid tetrasporophyte produces four haploid tetraspores within each tetrasporangium by undergoing meiosis. Tetrasporangia occur in the cortex (the outer edge of cells) of the thallus, and can be found anywhere on the blade. The tetraspores appear as red cross-shaped spots, and can be observed with a microscope or even a hand lens. When tetraspores are

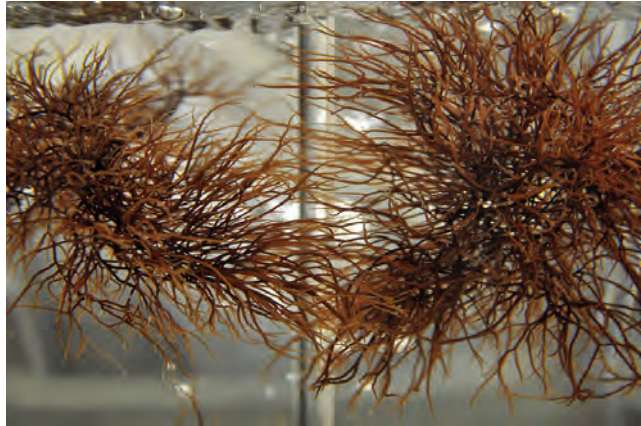

Figure 4.1. *Gracilaria tikvahiae* in culture



Figure 4.2. *Gracilaria tikvahiae*.

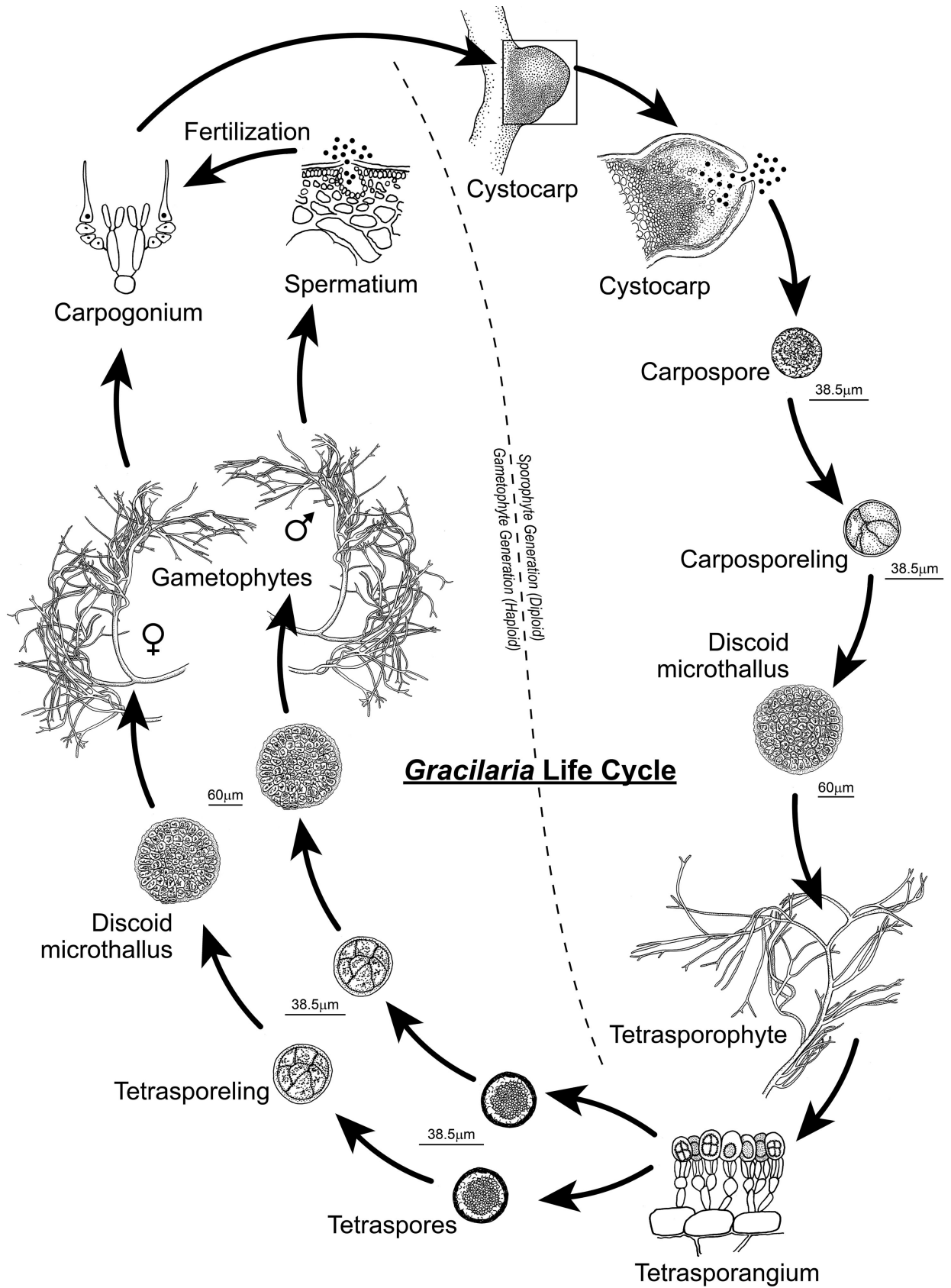

Illustration by Virge Kask, 2012 © Charles Yarish

Figure 4.3 The *Gracilaria* life cycle.

released from the blade, they drift passively in the water column until they settle and adhere to a substratum. The spore will begin to internally divide, then enlarge and develop a multicellular disc. The center of this disc will then develop a raised dome and the blade will develop from this initial growth. Each disc may produce many upright thalli, each of which may separate from the disc and continue to grow as a free-floating plant.

The plants that develop from tetraspores are either male or female haploid gametophytes, indistinguishable until maturity. Mature male gametophytes produce white spotted areas with spermatangia on their thallus, observable under a microscope. Female gametophytes become apparent when their eggs (carpogonia), produced within the cortex of the plant, are fertilized by spermatia (non-motile sperm), and new tissue develops around the zygote. The new diploid, globular structure is the third phase of the life cycle, the carposporophyte, occurring on the haploid female thallus. The small bump is a cystocarp, and inside the cystocarp, the original zygote undergoes many cell divisions (mitosis), eventually producing many diploid spores, called carpospores. These non-motile, spherical spores are released into the water column and carried to a suitable substratum by water currents. Once settled on a substratum, the spores will adhere, divide and form a multicellular disc. These multicellular discs will initially produce a protuberance that develops into an upright thalli, which will develop into tetrasporophytes, thus completing the life cycle. Each disc may also produce many upright thalli, each of which may separate from their disc and continue to grow as a free-floating plant.

Besides the relatively complicated three-phase sexual reproductive life cycle, *Gracilaria* is also able to reproduce asexually, through vegetative propagation. A single individual has the capacity to become hundreds or thousands of individuals, through continual fragmentation. Each fragment produced will grow and develop into an individual, and these blades can be further fragmented into several individuals, and so on. This is possible because the growth occurs in the apical meristem, which is growth from the tips of the branches. Each tip, then, has the capacity to grow and branch into its own blade. This allows for a much simpler means of propagation, and also creates consistency in a culture environment. Vegetative propagation is the most common means of culture, as it is quicker, easier, and more efficient than starting from spores, and it allows for consistency, as all blades in a culture can be genetically identical, all having the same parent (sometimes referred to as a clone). This is very important if the blades are being grown for a specific characteristic, such as agar consistency, specific morphology, or favorable growth rates and biomass yields. However, the vegetative propagation of a blade does not have an attachment stage, so the culture method needs to be adapted to the local needs and situation of the grower.

Cultivation

There are several different methods used for the cultivation of *Gracilaria*. The ideal system for any one grower may be a combination of two or several of these following options:

Culture Initiation

- Tip Isolation
- Spore Isolation

Biomass Production

Asexual (Vegetative) Propagation:

- Tank culture
- Suspended Rope Culture
- Bottom Culture

Sexual Propagation:

- Spore seeded substratum (the use of carpospores or tetraspores)

Culture Initiation

To initiate a culture, it is necessary to establish a unialgal culture (containing no other alga) by either spore or tip isolation. Clean, healthy, actively growing, and/or reproductive ‘parent’ fronds exhibiting desirable characteristics should be selected. Fronds (sometimes referred to a thallus) may be chosen from wild populations or from existing cultures.

When making a wild collection, fronds should be held and transported in an environment similar to (or cooler than) the one it was collected in to minimize stress. Deep pigmentation (rich color) is an indicator of healthy plants. Clean plastic bags, plastic containers, or buckets can be used for collection and transport. *Gracilaria* should be transported in moist paper towels or gauze to avoid drying and exposure. Regardless of the culture initiation method used, the critical step in culturing *Gracilaria* (or any seaweed) is the cleaning process. Any wild collected frond will be carrying a host of microscopic organisms (diatoms, protozoans, fungi, other micro-, macro-organisms, or cyanobacteria) that can potentially contaminate, inhibit or destroy cultures. An initial rinse of the seaweed in the field can remove any visible fouling organisms, followed by a more thorough cleansing process in the lab. Whenever possible, it is recommended to make voucher herbarium specimens for more rigorous genetic study.

A successful culture is established in the lab with a healthy, actively growing, unialgal isolate free of any contamination. A single successful culture can provide all of the ‘seedstock’ necessary to “seed” an entire farm. It is important to maintain a ‘seedstock’ culture in the lab for back-up and preservation purposes. To increase biomass from one isolate, fronds are fragmented and given sufficient light, space, and nutrients to multiply in number and size, and the process is repeated until enough biomass is reached to either “seed” a larger farm system or for direct harvest.

Tip Isolation

The area of new and active growth is located at the tips of every branch on a *Gracilaria* frond, the apical tissue. To obtain ‘starter plants’ for culture initiation, tips are cut from the parent frond, cleaned thoroughly, and placed in favorable growing conditions. Each tip will then grow, elongate, and branch into a new frond. To prepare a tip for isolation, a clean working area should be set up in a clean room with a draft-free, clean working space and a flame for sterilization of metal instruments to avoid any contamination of cultures. Because *Gracilaria* grows actively and becomes reproductive in the warm season, that would be the time to isolate tips. Reproductive *Gracilaria* can be easily identified by the cystocarps, which appear as protruding bumps along the surface of the branches.

Collected fronds from the field should be processed in a separate room from your culture isolation working space for the initial rinsing. The fronds are initially placed in the first container, and then fronds are individually selected and rinsed in a series of vessels by grasping with large forceps, submerging and shaking vigorously underwater several times. This can be repeated several times in a series of vessels where the last should contain



Figure 4.4 Cleaning wild-collected *Gracilaria* (from left to right): 1) Initial rinse in clean seawater; 2) Selection of clean, healthy fronds and second rinse; 3) Scrubbing and selection of tips for isolation

the fronds ready for tip isolation. If there are still epiphytes present on the tissue, gentle scrubbing with cotton balls, cotton-tipped swabs, or paper towels can remove any clinging organisms. *Gracilaria* is a euryhaline algae (able to tolerate a wide range of salinities), so a quick rinse (30-60 seconds) in clean, deionized freshwater can be used as a final cleansing step. A small section of the frond can then be removed for tip isolation, and placed in a small dish with sterilized seawater and moved to the clean working space (Figure 4.4).

The goal of tip isolation is to establish a clean culture. Clean and sterilize the working surface with an alcohol solution or disinfectant. The work area should be set up with sterilized jeweler's forceps (fine tipped tweezers), and a sharp scalpel or razor blade, all stored in an ethanol solution. This way metal utensils can be sterilized passing the tips through a flame (Bunsen burner or laboratory oil lamp). A small section of the parent frond is placed in a Petri dish with sterile seawater and healthy tips are excised with a scalpel or razor blade. Cut tips should be moved to another petri dish with sterilized seawater for cleansing. Tips should be about 2-3 mm in order to be able to grasp the cut end of the tip with jeweler's forceps for cleaning (Figure 4.5). The timeframe from the excising of tips to the outplanting of *Gracilaria* could be a minimum 6 month to one year. If your cultures become contaminated with other algae or cyanobacteria, you will have to start again from the beginning (isolation of tips).

Once a number of healthy tips have been excised, each tip is individually cleaned in sterile seawater. A series of Petri dishes can be set up in the working area to clean individual tips. A tip is placed in sterile seawater, grasped at the cut end with fine tipped forceps, and wiped down with a sterile cotton-tipped swap. This is followed by an agar drag through a prepared agar plate (see index for instructions), which will pull off any additional microscopic contaminants. A tip is held at the cut end with jewelers forceps and dragged through the

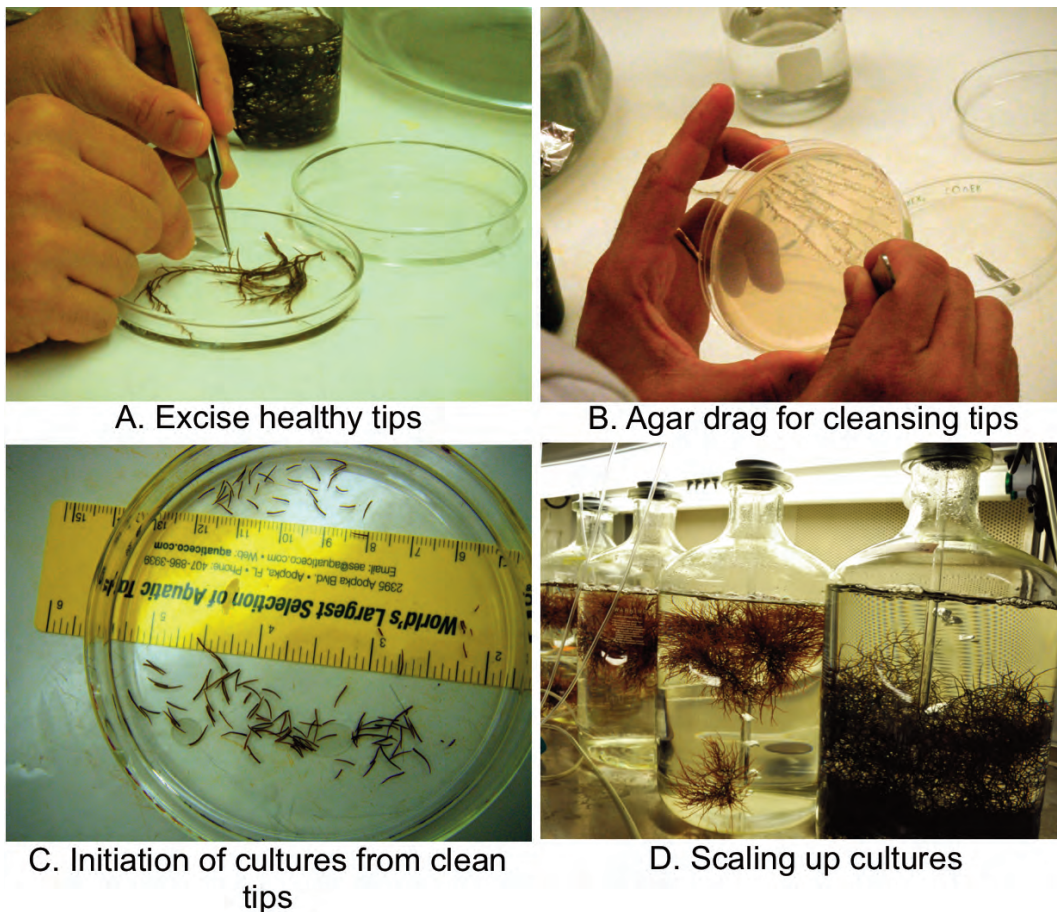

Figure 4.5. Isolating and cleaning tips for establishing clean cultures.

agar gel at least three times. Each drag should go through an unused portion of the agar gel. When the agar gel is used up, plates should be properly disposed of. The tip should now be free of contaminants, and can be placed in sterilized seawater prepared with Von Stosch's Enrichment media (VSE) and germanium dioxide (GeO_2). Multiple tips should be isolated from each frond in order to increase chances of obtaining a clean culture, because even all of these careful steps will not guarantee a unialgal culture. To maximize success, always check your culture under a microscope.

Individual tips can be isolated and cultured separately in small Petri dishes or flasks. They should be placed in VSE seawater with GeO_2 under low light ($10\text{-}20 \mu\text{mol photons m}^{-2} \text{s}^{-1}$), with a 12:12, L:D photoperiod, at 20°C ($=68.8^\circ\text{F}$). Lower light may discourage the growth of any remaining epiphytic contaminants. Tips will begin to elongate in about a week or two. Once tips have begun to grow and appear clean, light aeration can be applied to cultures to increase growth rates. Cultures should be changed once every two weeks initially, then once per week as growth rates increase. Once tips begin to elongate and branch into larger fronds, they should be transferred to larger containers to encourage growth.

Once a clean culture is established, it can be expanded through fragmentation, by breaking up one frond to start many new fronds. The growing environment is optimized to increase growth rates by gradually increasing light levels (up to $250 \mu\text{mol photons m}^{-2} \text{s}^{-1}$), increasing growing area (larger containers/tanks), and increasing frequency of media changes (to increase availability of nutrients). Clean glass culture bottles, jars, flasks or carboys of varying sizes are excellent for expanding or maintaining your cultures. Once a sufficient biomass is reached, the fronds can be transferred to larger indoor or outdoor tanks to expand further. To preserve or maintain original culture strains over long periods of time in the laboratory, growing environments are minimized, reducing light, reducing temperature, space, and frequency of media changes.

Spore Isolation

Clean cultures can also be initiated from either carpospores or tetraspores. Both types of spores can be released and isolated in the same way, though each will give rise to a different phase in the life cycle. Carpospores are obtained from mature cystocarps, which are apparent as bumps on the female thallus (Figure 4.6). These are easily identifiable, being obvious without the aid of a microscope. A microscope, however, is needed to observe the presence of the tetrasporangium on the thallus of the tetrasporophyte. These appear as small reddish spots scattered throughout the cortex of the thallus.

To ensure a clean release of spores, it is important to clean the parent frond well by shaking, scrubbing, and rinsing in sterilized seawater. Reproductive branches can be removed and wiped clean with a cotton-tipped swab and followed by an agar drag. A gentle desiccation period can be utilized to stimulate release of spores by wrapping the branch in damp paper towels, placing in a Ziploc® bag, and storing for a few hours or overnight in darkness or dim light. If fronds are mature, the desiccation period can be skipped and placed in seawater for release. To release spores, short sections of the fronds can be placed in sterilized seawater in a Petri dish over glass slides and kept under low light at 20°C . Release may take place at once, or can occur over several days. Spore release can be checked using a dissecting microscope.

Once spores are released, a small sample can be removed from the Petri dish and placed in a fresh dish with new media. Individual spores can then be selected with a very fine-tipped Pasteur pipette under a microscope. Selected spores are placed on cut glass slides ($25\text{mm} \times 25\text{mm}$) or on coverslips in small Petri dishes with sterilized VSE seawater. Dishes can be kept undisturbed at 20°C under $30 \mu\text{mol photons m}^{-2} \text{s}^{-1}$ light, with a 12:12, L:D photoperiod. Spores will settle within 12-24 hours after release, adhere to the glass slide, and begin to divide. After the initial division, the diameter will begin to increase as a multi-cellular disc is formed, a few days after settlement. The center of the disc will then undergo further cell division to create a raised dome in the center,

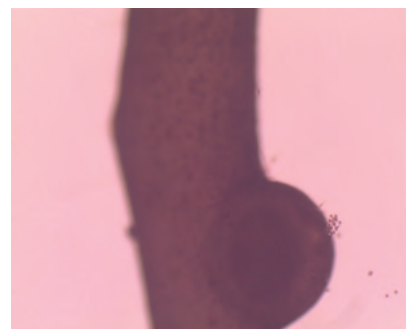

Figure 4.6 Carpospore release from a cystocarp formed on the surface of a female thallus.

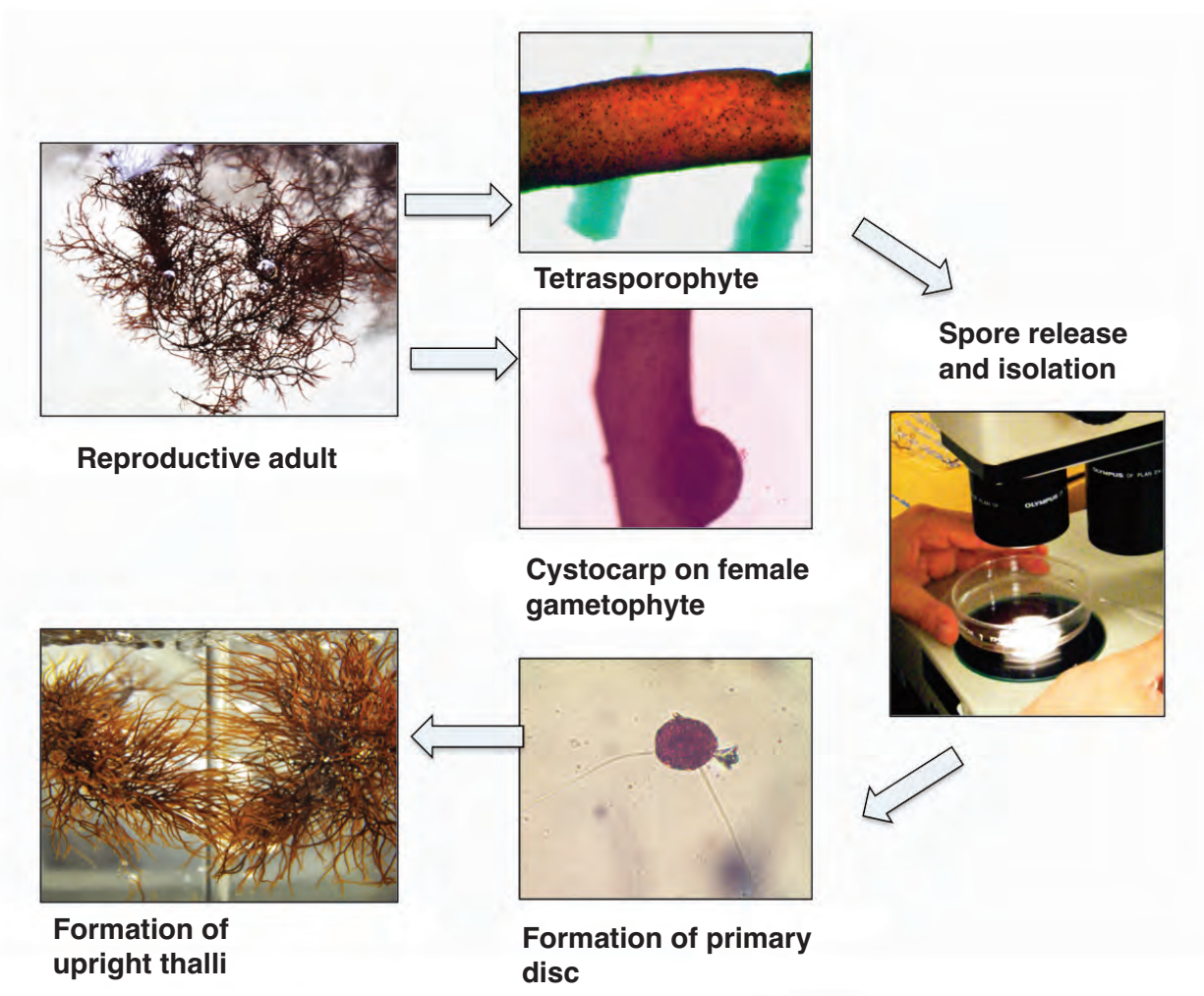

Figure 4.7 Isolation of clean *Gracilaria* laboratory cultures from spores.

but this is a slow process, taking up to 2 months to form a 2-3 cm cylindrical axis. This is the beginning of the new frond (Figure 4.7).

Spore initiation will result in an attached frond, and this can easily be transferred to new dishes by moving the glass slide, or the disc can be carefully scraped off the slide for an unattached frond. Once the first shoot begins to grow, light can gradually be increased every two weeks, aeration can be added and sufficient water changes and larger containers can increase growth rates (Figure 4.8). While spore isolation reduces the opportunity for contamination, the period of development is much longer than tip isolation. It can take 2-3 months to reach the size of an isolated tip. Spore isolation allows the grower to start new cultures from a known point, however, for more control over their cultures. If a culture is started from a carpospore, the grower can be certain that the resulting frond is a tetrasporophyte, and if started from a tetraspore, it is certain that the resulting frond is a haploid gametophyte, though it is impossible to determine the sex until the frond is mature.



Figure 4.8 *Gracilaria* lab culture. Establishing new fronds and building biomass.

Biomass Production

Asexual Propagation

The most common method of *Gracilaria* cultivation is through vegetative propagation. This is a simple process that allows the grower to start many new fronds from the tips of any single frond. This is a form of clonal propagation, where all of the new fronds started from the initial “parent” will be genetically identical, which is useful for consistency in production. This is probably the easiest form of propagation, but it results in unattached, free floating fronds, which lends itself well to tank cultivation, but presents some challenges for any type of attached culture.



Figure 4.9. Building biomass for *Gracilaria* culture: Laboratory scale, small tanks, medium tanks, large outdoor seawater tanks.

Culture Systems

Tank Culture

Gracilaria does very well in a tumbled tank culture system (Figure 4.9). This is due to its ability for unattached vegetative growth over long periods of time, ease of propagation, and high growth rates under ideal conditions. In this type of system, fronds are stocked in a tank of appropriate size and are given light, nutrients, and aeration. This type of system is intensive, requiring an input of energy (light, nutrients, and water movement) for culture. While tank culture may require more input energy, it allows for full control of the growing parameters as well as contamination control. It is the best method for developing ‘seedstock’ for further out-planting,

and will result in the most consistent production of fronds for edible or cosmeceutical/nutraceutical/pharmaceutical markets.

Aeration is a critical component of the tank culture, and is responsible for delivering several critical elements to the system. Aeration should be well distributed throughout the tank to deliver sufficient water movement to constantly ‘tumble’ the fronds around the tank. This allows for a higher stocking density, as the constant movement reduces shading limitation, increases light exposure, and increases photosynthetic efficiency throughout the culture. Aeration also increases availability of carbon dioxide and stabilizes the pH, which can rise to very high levels in an actively photosynthesizing culture. Water movement created by aeration simulates natural water currents, which are important for delivering nutrients to the surface of the fronds. Seaweeds will take in nutrients from the surrounding water, and if there is no water motion to replenish the water around the thallus,

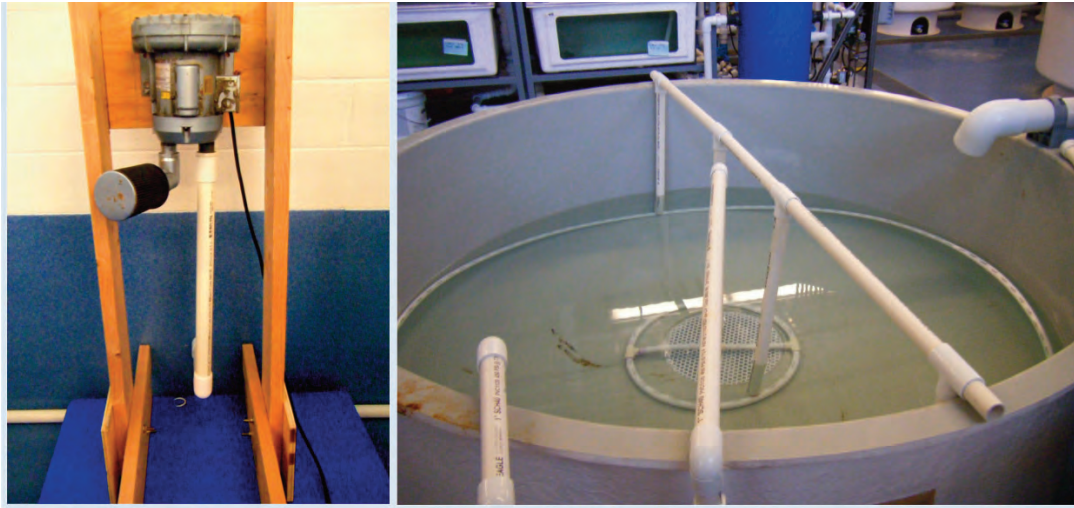

Figure 4.10. Aeration system for tank culture. A blower with air filter and aeration tube arrangement for a round tank.

a “boundary layer” of nutrient-depleted water will be established, and growth will be reduced. Turbulence can also help reduce growth of contaminants on the fronds.

Any type of air blower can provide aeration, though the air should be filtered before entering the cultures (Figure 4.10). The distribution of air can be established by running rigid tubing or PVC pipes throughout the tanks to create full circulation. Air should be moving up from the bottom of the tanks on the outside and the center of the tank to ensure there are no ‘dead spots’ where fronds could accumulate.

The addition of sufficient nutrients to a culture is essential to obtain maximum growth rates and biomass yields. In a tank culture, this can represent a system expense, though the coupling of seaweed tanks with other ‘waste’ streams for alternative nutrient supplies is a possibility, as *Gracilaria* has a high bioremediation potential. Some alternative nutrients may include waste from other cultured animals (fish or shellfish), sewage, or fermentation residue from anaerobic digesters. In the absence of an alternative fertilizer, conventional land-plant fertilizer may be added. Fertilizer should be added in small daily increments to avoid ammonia toxicity. *Gracilaria* is able to take up nutrients in excess of their immediate needs and store these ‘reserves’ in their tissue for use in nutrient depleted situations. This storage capacity is useful to the farmer, for fronds can be ‘fertilized’ by soaking in high-nutrient media for 6-12 hours, then transferred to another site that may be low in nutrients. The seawater media in a culture should be changed on a regular basis to remove possible contaminants and to provide fresh nutrients. Larger cultures can be monitored for nutrients levels and half of the water volume changed on a regular basis to conserve inputs.

Light should be provided to the culture system in such a way to maximize growth while minimizing cost. Initially, lighting inside the laboratory can be provided with fluorescent lights or greenhouse growing lights, and light should be placed on a photoperiodic timer. As the culture system is expanded, natural lighting should be

utilized, though fronds should be protected from extreme exposure by covering with neutral density screening. A light meter is an essential tool for determining and adjusting light levels as appropriate. Light (given non-limiting levels of nutrients) is an important parameter for controlling pigment levels in *Gracilaria*, and a controlled environment allows the grower to adjust light levels for desired pigment levels or the production of photo-protective pigments. This may or may not be important, depending on what the final product is being sold for. Light, aeration, and nutrients all work together to produce the final product. It is important to ensure that all fronds are exposed to enough light through constant turn over and tumbling, and nutrients need to be provided at non-limiting levels to allow for optimal growth rates, given sufficient light.

The culture is easily expanded by breaking apart, or fragmenting, the fronds, which will continue to branch and grow into new fronds (Figure 4.11). The culture should be kept at a density that will maximize growth with efficient use of the resource inputs (e.g. 2-4 g L⁻¹). As the culture expands, the density can be reduced by removing fronds or by moving to a larger container or tank. This is an efficient way to grow up a large amount of initial biomass for further cultivation in a field setting or in larger tanks. For more in-depth discussion of lab and tank rearing technologies see Craigie and Shacklock (1985), Craigie (1990) and Craigie *et al.* (1999).



Figure 4.11. Building biomass in a tank culture through fragmentation of fronds.

Suspended Rope Culture

In order to reduce input costs of culturing seaweeds, field culture is an option, wherein seaweed fronds are placed out in the coastal environment to take advantage of the available natural resources. This is an extensive farming practice, where inputs and labor are relatively low, compared to the highly controlled intensive laboratory and tank culture. Suspended rope culture is a relatively simple fixed grow-out system, comprised of a floating longline held in place by anchors and buoys. *Gracilaria* plants are attached to the line by entwining or tying, and are further grown out on the lines (Figures 4.12, 4.13). *Gracilaria* can be outplanted on longlines when temperature rises above 15°C (60°F). As biomass increases, fronds can be harvested by ‘trimming’ the outer portion of fronds and leaving fronds to re-grow to cut again every two to four weeks, or by a total harvest, by taking in the whole frond. Culture sites will vary considerably in their conditions, and local prevailing light, temperature, nutrient and salinity conditions should be determined for optimal growth (Figure 4.14).



Figure 4.12 *Gracilaria* bundle inserted in line for field culture.

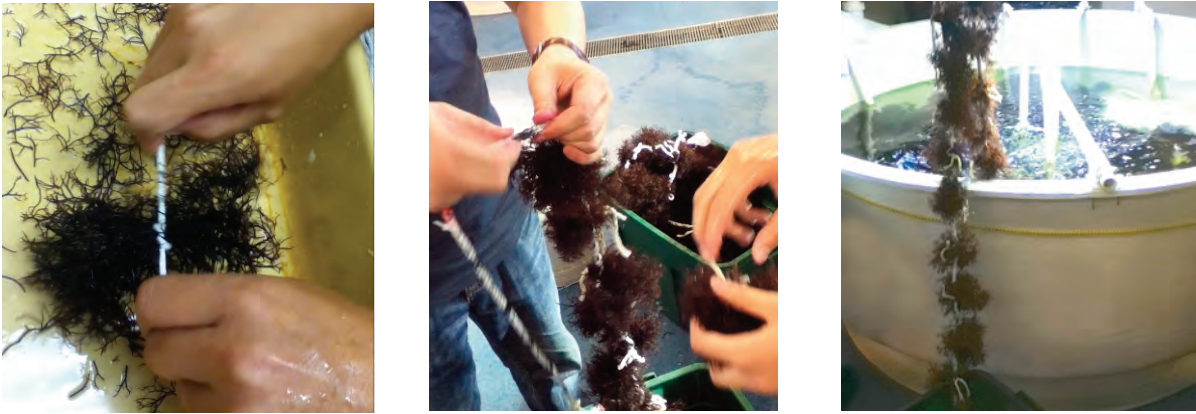

Figure 4.13. Inserting *Gracilaria* bundles onto a longline for out-planting.

Problems associated with field culture of *Gracilaria* include grazing, fouling, and environmental stress. Grazing by herbivorous fish or other predators is not as much of a problem in the Northeast as in the warmer climates, but smaller grazing animals are a possibility. Fouling is the biggest challenge in an open water grow-out situation. Many different types of fouling organisms may settle on the lines, including epibionts, such as tunicates, hydroids, bryozoans, mussels, worms, and amphipods, and epiphytes, such as other green, red, and brown seaweeds or microalgae. There are several methods available for minimizing fouling. These include controlling depth, stocking density, and out-planting or harvest time. Depth can be adjusted to minimize settlement or survival of particular organisms. Increasing stocking density and maximizing growth rates will allow the fronds to outcompete or exclude potential fouling organisms. All organisms in the Northeast, including fouling organisms, have seasonally controlled life cycles. Once the life cycle is understood, timing the out-planting of the seaweed lines and harvest of the crop can be a very important method for avoiding fouling settlement windows.



Figure 4.14. *Gracilaria* open water farm (left). Deployment and cultivation of *Gracilaria* on longlines in the open water farm (middle). The harvesting of *Gracilaria* bundles (right).

Extreme weather events can pose a hazard to the farm, either by causing damage to the infrastructure or by stressing the fronds. Farms should be sited in protected areas, and should be strong enough to withstand storms or high wind events. Flexibility in the design of a farm is important to minimize losses. An example of farm risk management would be the ability to bring lines in for storage in holding tanks during dangerous storms, or being able to adjust depth so that lines could be lowered to avoid extreme wave action or runoff events. *Gracilaria* is a stress tolerant species, but extreme changes in light, salinity or temperature can stress a culture unit and reduce growth and production.

Bottom Culture

Bottom culture is a popular culture technique in warm temperate climates, but may be difficult in the Northeast due to leasing area limitations. Bottom culture involves either growing fronds that are 'seeded' onto rocks and spread on the bottom in a shallow area, or by attaching fronds to lines that are strung on stakes and suspended just above the bottom. The technique of suspending lines from stakes is very similar to the suspended line culture, but is a little less flexible with depth adjustment. Access, however, may be easier in shallow sites.

Sexual Propagation:

Spore seeded substratum (carpospore or tetraspore)

Spore seeding is an alternative means of *Gracilaria* propagation. Instead of fragmenting a frond to produce new fronds, spores from a mature carposporophyte or tetrasporophyte are seeded onto a substratum, allowed to develop into juvenile fronds, and placed out into the growing area. The advantage of spore seeding is the convenience of attached fronds, while the disadvantage is the long incubation period to grow the settled spores into young fronds. The development of a juvenile frond 1-3cm in height can take two months in culture. Spore-originated fronds can also exhibit a higher level of polymorphism, since all fronds are not genetically identical, as with the asexually propagated fronds. This will increase capacity for adaptation and survival in fluctuating or changing environments, but may not be ideal for a specific commercial purpose.

Spores can be released over the desired substrata (seed line or rocks) by laying prepared, mature spore-bearing thalli on a screen suspended in water. Spores are released over a 2-4 day period at 20°C, and once released, spores are allowed to settle undisturbed for 24-42 hours in dim light. If seeding both sides of a line wound on a frame, the frame is inverted and the same release and settlement period is done for the other side. The seeded substratum is then kept at 20°C under low light (20-40 $\mu\text{mol photons m}^{-2}\text{s}^{-1}$) for approximately two months for development of the juvenile fronds. Culture media (VSE) should be changed every two weeks to start, then more often as fronds start to develop. Gentle aeration can be applied for water movement. Once juvenile fronds are visible, they can be transferred to the culture site. A protected site should be chosen to avoid frond loss in high-energy environments.

Spore seeding of rocks may be a way to reseed or restock natural populations of *Gracilaria*. Once the fronds are established, the seeded rocks can be broadcast on the bottom of a protected shallow area, in order to help reestablish natural populations or supplement harvests.

Mixed Culture Methods

Several different culture methods may be employed in the culture of *Gracilaria*, and best practices will depend on the facilities available to the grower. Fronds grown in tanks may be used to stock long lines, and additional spore seeding of ropes may be possible to supplement the harvest and increase productivity. Other types of grow out systems are possible, including net tubes instead of lines, or floating cages stocked with unattached fronds. A 'spray culture' is another option, where recirculating water is sprayed continuously over fronds that do not have to be submerged in a tank of seawater. Fronds grown in areas or time periods of low levels of nutrients in the field can be 'fertilized' by placing in land-based tanks with high levels of nitrogen for 6-12 hours, then placed back into the field. Successful culture and production will depend on the grower's flexibility, inventiveness, and good management practices. For more in-depth discussion of cultivation techniques the reader is urged to consult Yarish and Pereira (2008).

Chapter 5. *Chondrus crispus*

Chondrus crispus Stackhouse, known commonly as Irish moss, is a member of the Phylum Rhodophyta, or the red-seaweeds (Figure 5.1.). The commercial importance of *Chondrus* comes from the production of carrageenans, a family of polysaccharide gums often collectively referred to as phycocolloids. The chemical and physical properties of carrageenans have applications in the food and pharmaceutical industries, making them highly desirable and valuable. They are used as binding agents in such items as ice cream, toothpaste, and pudding. *Chondrus* forms lambda (λ) and kappa (κ) carrageenans, in the tetrasporophyte and gametophyte generations, respectively, which differ in gel strength (Craigie & Shacklock, 1995). In 2003, the world carrageenan market was estimated to be worth USD \$240 million. However, the carrageenan market has undergone a shift from reliance on wild harvested *Chondrus* to cultivated carrageenan producing red seaweeds such as *Kappaphycus alvarezii* and *Euchema spinosum*, particularly from the Philippines (FAO, 2003). *Chondrus* is grown commercially as a sea vegetable by Acadian Seaplants, LLC in Nova Scotia.

The geographic distribution of *Chondrus* spans the North Atlantic coasts of North America, ranging from Long Island to Labrador, and Europe, ranging from Norway to Morocco (Mathieson & Prince, 1973). Vertically, *Chondrus* grows in mid-tidal pools, the low intertidal zone, and subtidally to 16-18 meters (Bird & McLachlan, 1992; Figure 5.2). Fronds are recognized as bushy dark red clumps that are generally less than 12 cm high, although they can reach 32 cm in some locations. Morphologically, they are quite variable ranging from compact, bushy plants to large, more loosely branched fronds. Colors range from blackish red to yellowish tints. They are dichotomously branched and apices vary from blunt to toothed to fringed. *Chondrus* is a perennial species, having individuals that can survive for at least two years, with the majority of growth occurring during the summer months (Bird & McLachlan, 1992).

Biology

The general life history of *Chondrus crispus* (Figure 5.3) includes three stages or generations: an asexually reproducing tetrasporic stage (diploid), a sexually reproducing gametophyte stage (haploid) with separate male and female individuals, and a microscopic carposporophyte stage that develops on female blades after fertilization (Mathieson & Prince, 1973).



Figure 5.1 *Chondrus crispus* blades in culture



Figure 5.2 *Chondrus* bed at low tide.

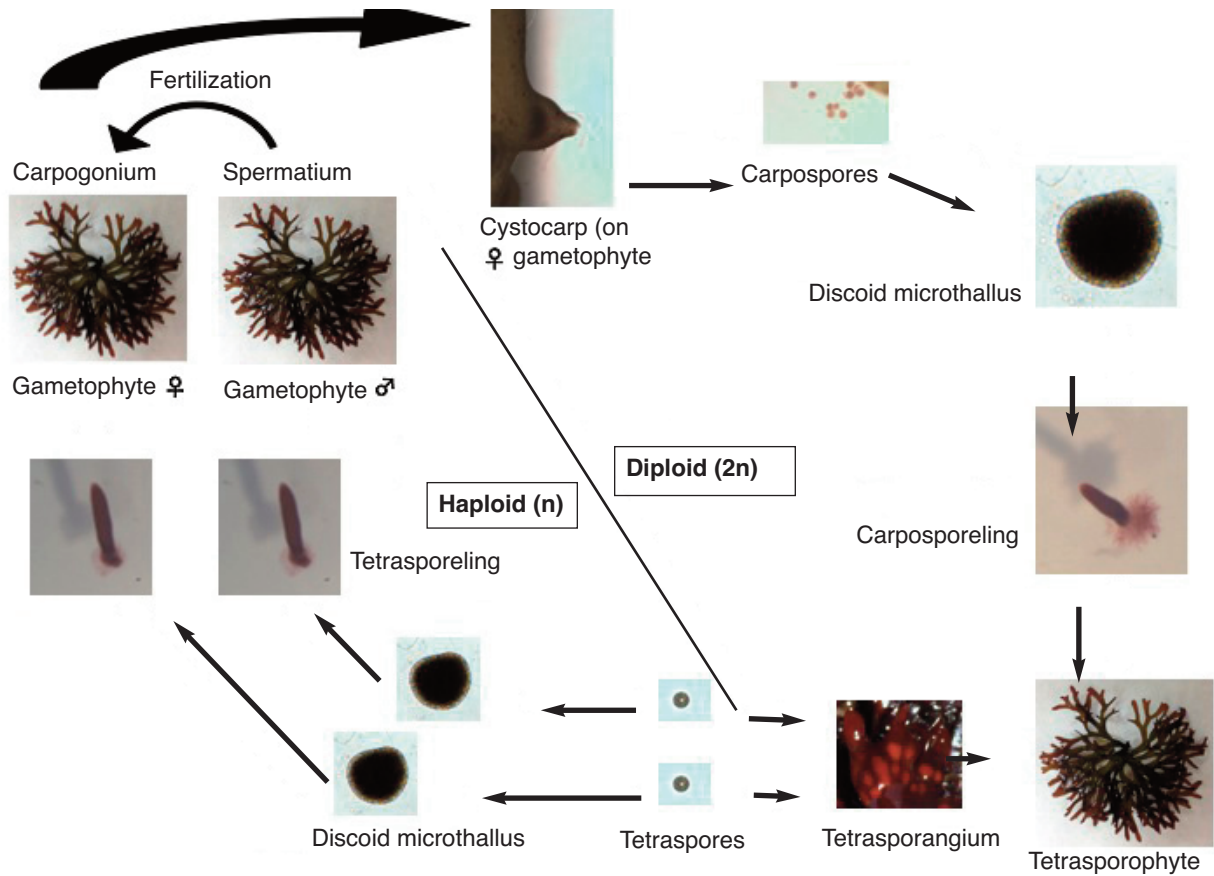

Figure 5.3. Life history of *Chondrus crispus*.

The gametophyte and tetrasporophyte generations are similar in appearance (i.e. isomorphic), but can be distinguished by their reproductive structures. Non-motile male gametes are released from gametangia that appear as white spots on the male blades. After fertilization, female blades can be recognized by the presence of small round bumps called cystocarps that contain the carposporophyte generation. Carpospores are released by the carposporophyte and when they settle on suitable substratum (rock or shells) they grow into the tetrasporophyte generation. Tetrasporophytes form asexual tetraspores in small opaque patches visible on the blade. When tetraspores are released and settle, they germinate and develop into female and male gametophytes (Chen and McLachlan, 1972). In the field, the male fronds are difficult to detect but have been recorded during June and July and from October through December. Female fronds with cystocarps occur throughout the year, but are most prevalent in the summer and autumn months. Tetrasporophytes also occur year-round.

An important process in the growth of sporelings of *Chondrus crispus* is sporeling coalescence (Figure 5.4). Sporeling coalescence occurs when spores grow together, forming rafts (Tveter and Mathieson, 1976). If sporeling coalescence occurs early in the development of the spores, a limited number of upright fronds will be produced but these fronds exhibit enhanced growth. If coalescence occurs in older sporelings, then the number of uprights is not impacted and spores coalesce simply from lateral expansion or overlap. Coalescence is common in both gametophytes and sporophytes of *Chondrus* most likely because spores are typically discharged in a sticky bundle and settle close to one another. It is more common in sporophytes, probably due to the fact that only gametophyte spores of the same sex can coalesce. Enhanced growth of fronds that are the result of sporeling coalescence has also been described in detail in *Gracilaria verrucosa* (Jones, 1956) and *Gracilaria chilensis* (Muñoz and Santelices, 1994).

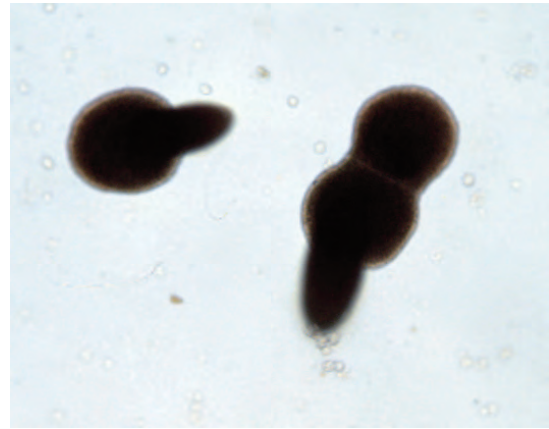
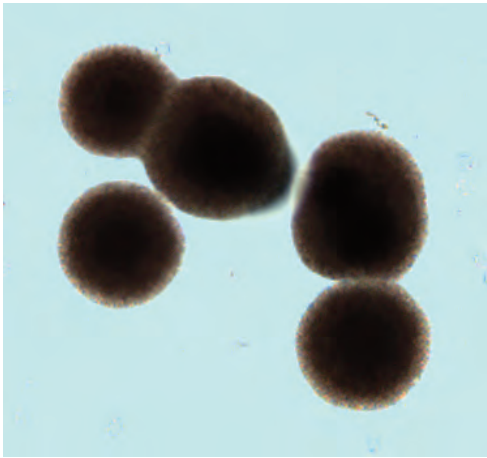

Figure 5.4 Sporeling coalescence in *Chondrus crispus*.

Cultivation

Nutrient Media

Von Stosch Enriched Seawater (VSE, see Appendix) is the preferred medium for laboratory culture of *Chondrus* (Figure 5.5). Six stock solutions are made up separately, filter sterilized and mixed when needed. Full strength Von Stosch medium requires 1 mL of mixed VSE solution per 1 L of seawater. For *Chondrus* cultures, the VSE enriched seawater medium needs to be changed weekly. If you are growing *Chondrus* in an integrated multi-trophic recirculating aquaculture system then the nutrients required should be produced by the fed crop (i.e. fish or shrimp). Typically in these systems, very little or no addition of nutrients is required.

Light

Light can be a limiting factor in indoor culturing tanks or in tanks with high stocking densities and low agitation rates. As might be expected, growth increases with increasing light, but only up to a point. In laboratory culture, *Chondrus* reaches a maximum photosynthetic rate at a light level between 200-250 $\mu\text{mol photons m}^{-2} \text{s}^{-1}$. To put this in perspective, the outside sunlight level at noon in the summer is about 2000 $\mu\text{mol photons m}^{-2} \text{s}^{-1}$. Exposure to excessively high light levels can actually inhibit growth and damage the plants, but as an intertidal species, *Chondrus* can acclimate gradually to daylight conditions. Previously constructed tank systems for *Chondrus* were artificially illuminated to a maximum of 700 $\mu\text{mol photons m}^{-2} \text{s}^{-1}$ without negative impacts on productivity. In tank-based grow-out systems, the use of natural sunlight may reduce energy costs for lighting, but the savings may be lost by the need for cooling during warm weather. Cultures reared at lower light conditions will acclimate to lower light, but growth rates may be significantly decreased.



Figure 5.5. *Chondrus* in culture.

Studies have shown that *Chondrus* can be grown under constant light (i.e. 24 hours of light) with no negative impacts (Bird *et al.* 1979). Trials conducted at the University of New Hampshire compared growth rates under short day (8 hours light :16 hours dark), day neutral (12:12) and long day (16:8) conditions and found average growth rates of 3.6, 5.4, and 4.6% per day with no significant differences attributable to day length.

Temperature and Salinity

Chondrus has optimal growth at 20°C, but can survive in temperatures ranging from -1.9°C to 26°C (Prince & Kingsbury, 1976, Enright & Craigie, 1981, Simpson & Shacklock, 1979). Laboratory studies conducted at the University of New Hampshire found no significant difference at 10°C, 15°C and 20°C with growth rates averaging 4.5, 5.0, and 4.2% per day, respectively. These studies were conducted on material cultured from spores of wild material collected throughout the southern Gulf of Maine. Consequently, *Chondrus* can be grown over a wide range of temperatures, which allows it to be integrated into a variety of fish and/or invertebrate aquaculture systems.

Chondrus can also tolerate a wide range of salinities from 10-58 parts per thousands (ppt), but is reported to have a growth optimum in the narrow range near 30 ppt (Craigie & Shacklock, 1995). In a laboratory culture experiment, Craigie and Shacklock (1995) found that the growth response of *Chondrus* to salinity resulted in a bell-shape curve with lowest growth at 5 and 45 ppt and peak growth at 30 ppt. Typical coastal seawater water has a salinity around 32 ppt.

Processing Wild Collected Material

Chondrus crispus can be easily collected during low tide at most rocky shore coastal locations in New England. *Chondrus* typically forms beds near the low tide line and can also be found in tide pools. When collecting material, care should be taken to locate specimens with visible cystocarps or tetrasporangium, which indicates that the specimen is reproductive and that spores can be obtained (Figure 5.6). Cystocarps are recognized as parasitic “bumps” on the female gametophyte while tetrasporangium can be seen as oval packets inside of the blade when it is held up to the light. Plants with cystocarps will yield carpospores that grow into tetrasporophytes, while tetrasporophytes will release tetraspores that grow into female or male gametophytes (see Figure 5.3). Either generation can be used to obtain seed stock for *Chondrus*.

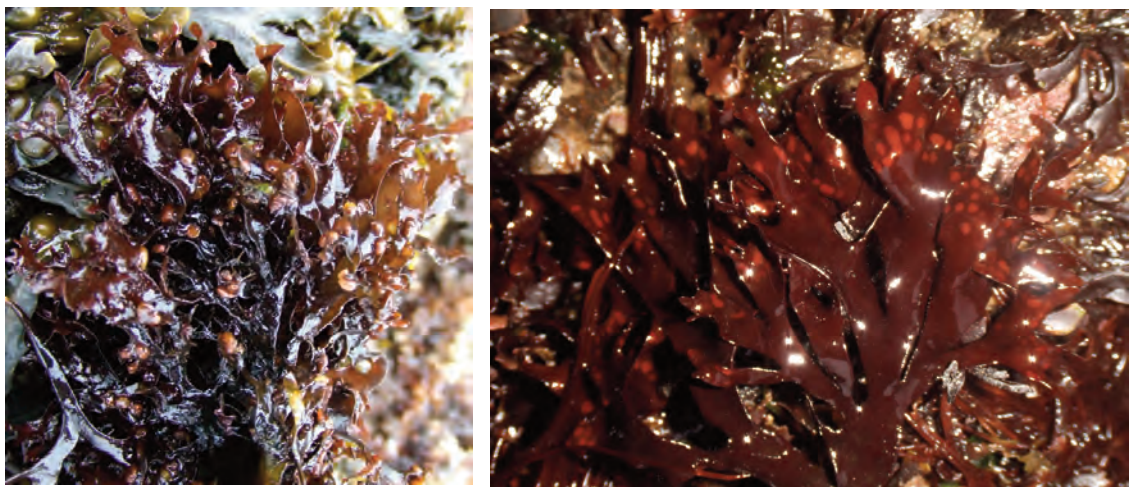

Figure 5.6. Reproductive blades of *Chondrus crispus*.
The carposporophyte (cystocarp parasite on the female gametophyte, left) and tetrasporophyte (right).

After reproductive samples have been located, they should be placed in Ziploc® bags with air, but no water and placed on ice for transport to the lab. After arrival at the lab, samples should be kept in the refrigerator and processed as soon as possible. Using a dissecting microscope, reproductive portions of the blade can be excised with a sterile razor blade (Figure 5.7). It is important during this process to eliminate as much non-reproductive tissue as possible. The excised reproductive tissue should be rinsed in sterile seawater several times and cleaned with sterile cotton balls to remove epiphytes. The clean reproductive material can then be placed into sterile Petri dishes with seawater and kept at 10-15°C and a light level of 10-100 $\mu\text{mol photons m}^{-2} \text{s}^{-1}$ for spore release.

Spore Isolation

After approximately one hour in the Petri dishes, samples should be checked for spore release using a dissecting microscope. Spores appear as small round red spheres or balls and an indication of spore release is a ruptured “volcanic” looking cystocarp or tetrasporangium. If spores are not visible, check the cultures every hour until release occurs. If spores are present, isolation should occur immediately.

For spore isolation, autoclaved Pasteur pipettes are heated above a flame and pulled to a fine tip using tweezers. This fine tip will allow individual spores to be picked up. Using vacuum pressure created by placing the thumb over the end of the pipette to seal it, locate an individual spore under the dissecting microscope, carefully place the pipette adjacent to the spore and slowly release the thumb from the end of the pipette to allow the spore to be collected in the pipette (Figure 5.7). The spore should be transferred into a single well of a 24 (or 12-well) culture plate with approximately 3.3 (or 6.6 mL) of sterile Von Stosch Enriched Seawater. The spore is expelled from the tip by gently blowing through the pipette until small bubbles of air are produced in the well. The procedure should be repeated until the desired numbers of spores are isolated from each sample. An alternative method is to isolate individual spores into sterile shallow Petri dishes containing pieces of sterilized glass microscope slides. The spores settle onto the glass surface to grow allowing for ease of transfer and manipulation. All materials used in the processing of blades and isolation of spores need to be autoclaved or flamed to ensure sterility. Multi-well plates or Petri dishes of spores can be maintained at 10-15° C and 10-200 $\mu\text{mol photons m}^{-2} \text{s}^{-1}$ light (Figure 5.7).



Excise reproductive tissue and rinse with sterilized seawater.

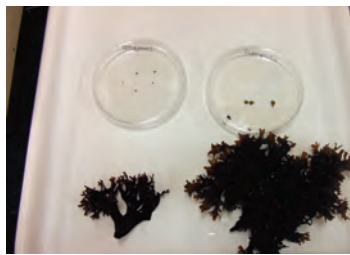

Place excised tissue in sterilized seawater.

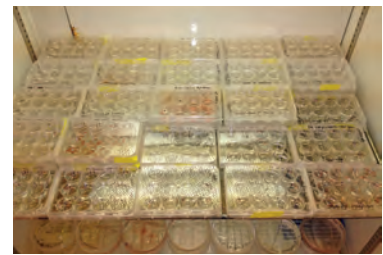

Place Petri dish at 10-15°C under 10-200 $\mu\text{mol photons m}^{-2} \text{s}^{-1}$.



After spores are released, isolate using pulled Pasteur pipettes.

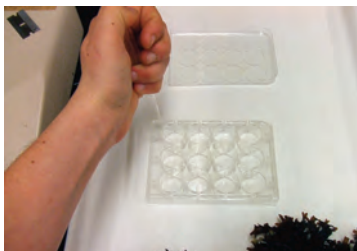

Place isolated spores in multi-well or Petri dishes (optional glass slides).



Change media weekly and transfer when large enough.

Figure 5.7. Spore isolation procedure for *Chondrus crispus*

After spores have grown into blades of visible size (at least 1 mm) they can be transferred into aerated Erlenmeyer flasks to enable faster growth. The blades can be gently scrapped off of the bottom of the culture plate wells using a sterile scalpel blade or tweezers. Care in this step should be taken to not dislodge any plastic material from the bottom of the well, as the transfer of this material into flasks will often encourage contamination. The small blades can then be rinsed from the culture plate wells into appropriately sized Erlenmeyer flasks (i.e. 1 L) using sterile seawater. Transfer to flasks is much easier if spores were allowed to settle onto pieces of microscope slides rather than directly onto the bottom of the well or Petri dish. Once the small plants have been transferred, the flask is sealed with a sterile rubber stopper fitted with a rigid plastic tube, and bacterial air filter (Figure 5.8). The aeration tube is then attached to an air pump and the flow rate is adjusted so that the blades are slowly circulating in the flask but not bubbling onto the sides above the water.

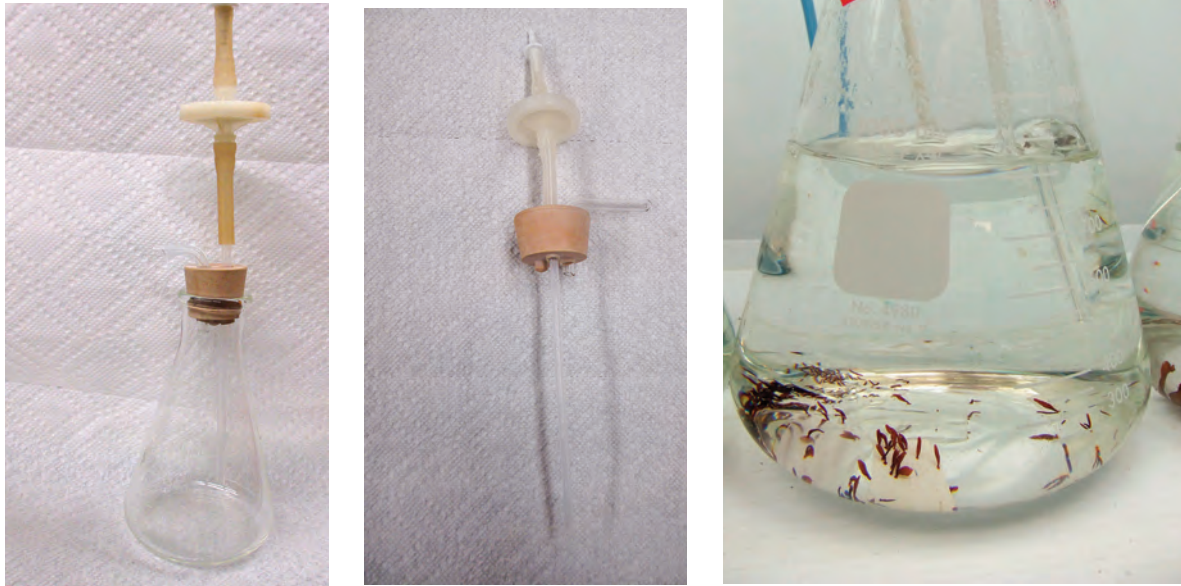

Figure 5.8. An Erlenmeyer flask with aeration tube and aeration tubes separately (left). The stoppers must have at least two holes so that the sterile tube can pass through one and the other can serve as a vent. In these a bent glass tube is used to prevent contamination from falling into the vent hole. Sterile needle tips can also be used to vent. *Chondrus* spores settled onto glass slides that have been transferred into a 1-liter Erlenmeyer flask (right).

Tip Isolation

Chondrus can also be propagated from the tips excised from spore cultures or directly from wild collected plants. *Chondrus* grows from its apical tips (i.e. the very tip of the blade is the part that is growing, not the base of the frond) and therefore tips can be periodically chopped up to increase the number of plants and biomass. This method is the most common in commercial mariculture of *Chondrus* as it eliminates the need to induce reproductive development and release reproductive spores to get new vegetative growth.

Cultures should be maintained under continuous aeration and seawater should be exchanged in laboratory cultures weekly with new VSE media. There are several other options for seawater enrichment depending on whether the seawater you are using is natural or artificial. The appendix provides more information on this.

Chondrus cultures can be maintained, cutting tips periodically until the desired biomass is achieved. As they grow, it is beneficial to transfer them into larger flask (i.e. 4 L Erlenmeyer flasks) to promote growth (Figure 5.9). While it is possible to use an aquarium at this stage, it is discouraged, because it is impossible to maintain sterile conditions in aquaria. Furthermore, even with the best aeration there are often dead zones in aquaria that allow for the settling out of seaweed onto the bottom. Constant motion of blades ensures optimum uptake of nutrients and more even exposure to high light levels to enable faster growth.

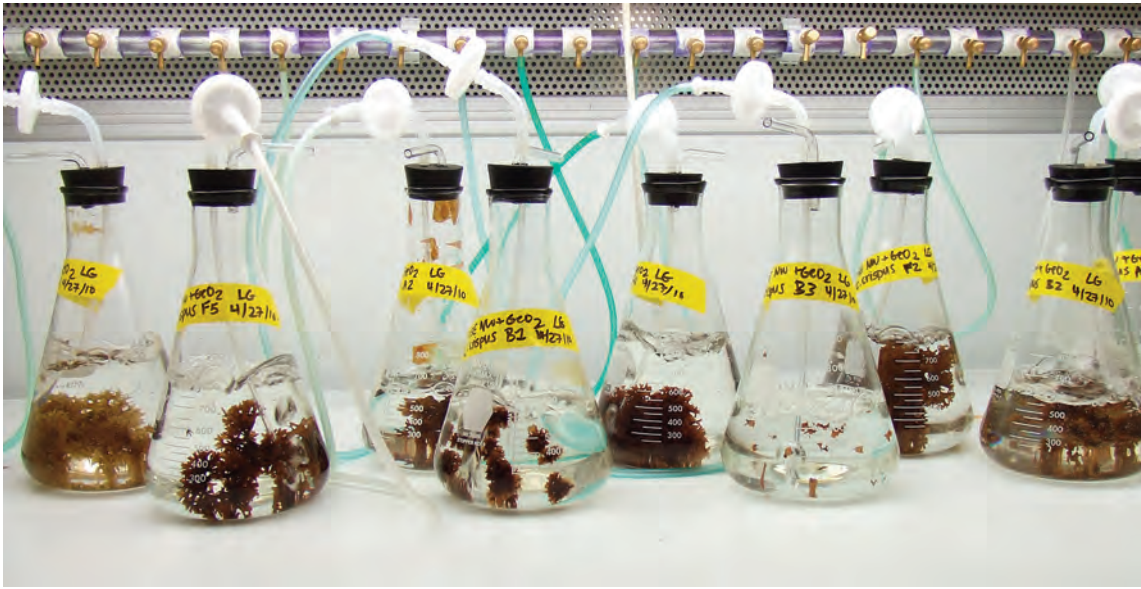

Figure 5.9. Vegetative culture of *Chondrus crispus* isolated from spores. Cultures are maintained in a cold room at 15°C.

Transfer to Tank-Based Systems

When the desired amount of biomass is obtained, cultures can be moved to tanks of different sizes. As mentioned above, periodic cutting of tips will lead to continued vegetative growth. The conditions required for successful tank-based mariculture of *Chondrus crispus* have been discussed previously in this section. Tanks can range from 5 gallon to thousands of gallons depending on the operation. A small aquarium sized air pump can be used to supply air in smaller tanks and larger pumps will be needed for larger tanks.

Strain Selection

When cultivating an alga, the choice of species depends on the product to be marketed, whether for human consumption, cosmetics, or pharmaceuticals. Once the species is chosen, a strain with desirable characteristics can be selected through a screening process. This process takes into account many factors including the performance of the alga in the local environment and a gradient of responses that the alga has to environmental factors (Craigie, 1990). If the cultivation of the alga is to occur in the ocean environment, then specific criteria must also be met when selecting a site. As mentioned previously, different life stages of *Chondrus* have the ability to produce different types of carrageenans. Because the cultivation of *Kappaphycus alvarezii* in the Philippines has met most of the demand for κ -carrageenan, there has been a push to develop *Chondrus* as a source of λ -carrageenan, which comes from the tetrasporophyte generation (Craigie, 1990). Since cultivation of *Chondrus* is primarily land-based, the tetrasporophyte strain chosen must be suitable for tank culture conditions (Craigie & Shacklock, 1995).

Culture System

To start a culture system for *Chondrus* there are several things that you will need in addition to basic laboratory supplies. These include a supply of sterile seawater for weekly exchanges, a cold room kept between 10-20°C (alternatively a chiller with a circulation pump can be used to create a temperature controlled water bath), pumps for supplying air, and a source of light (Figure 5.10). Normal room lighting is not adequate for optimal seaweed growth. However a high output fluorescent light fixture with cool-white lamps placed very close to the flasks or tanks will work adequately. A light meter will help you to adjust the levels appropriately.

Chondrus is typically cultured in tank systems. In a laboratory setting, fronds are transferred periodically into larger containers or flasks according to growth rate and size, and tips are cut periodically to encourage vegetative growth. To stock a large tank, produce as many tips as possible and then add them to the tank in the desired quantities. Low stocking densities for *Chondrus* are 4-6 kg m⁻² and high stocking densities are 8-12 kg m⁻² (Bidwell *et al.* 1985).

Plants can then be added to large aquaculture tanks if desired and allowed to grow until harvestable size. If tanks need to be maintained at low temperatures, then a chiller can be used although they require an outside pump for circulating water. Tanks can also be wrapped with insulation such as foam board to decrease the rate of heat exchange between the tank and the outside environment and conserve energy. If the seaweed is to be added to an already existing recirculating tank system then this equipment is probably already in place, however, seaweed should not be grown in the same tank as fish. Fronds should be monitored for signs of reproductive development. If fronds become reproductive two things should occur: 1) several blades should be selected to undergo spore release to achieve further seed stock generations and 2) blades should be harvested prior to release of spores in the aquaculture tank as this can cause clogging of filters and a coating of spores on the tank that can be very difficult to remove.



Figure 5.10 Culture system.

Considerations for Grow-Out in Tank-Based Systems

Several types of tank-based systems can be used to grow *Chondrus*. Typically, tank-based Integrated-Multi Trophic Aquaculture (IMTA) systems are recirculating (i.e. closed). In these types of systems, there is little if any seawater exchange as the goal is to conserve water through recirculation. Tanks containing seaweeds in recirculating systems will still require temperature regulation, aeration (i.e. plant agitation), and light. Nutrients for seaweed growth will be supplied by the fed crop.

Seaweeds can also be grown in flow-through systems where the water enters at one end and leaves at the other. In these systems, seawater exchange rates must be considered. Below is an outline of the important factors in a flow-through *Chondrus* system published by Craigie & Shacklock (1995) based on their cultivation work in Canada. Keep in mind that recirculating systems share some of these factors but face unique challenges of their own.

Seawater Exchange Rates

When culturing *Chondrus* in tanks, seawater exchange rates must be adequate to ensure proper removal of waste metabolites and delivery of required nutrients. Flushing rates must equal or exceed the rate at which phytoplankton (microscopic photosynthetic algae) contamination, waste metabolites, and frond debris accumulates in the tanks (Craigie & Shacklock, 1995). Tank systems typically have water exchange rates between 3 and 7 tank volumes per week (Craigie & Shacklock, 1995). Water exchange can also be an important mechanism for temperature control and the addition of certain nutrients such as carbon through the bubbling of CO₂. Systems can be set up to be fully automatic and respond to parameters such as temperature, irradiance, and pH (Bidwell *et al.* 1985).

Plant Agitation

Another important consideration in tank culture is a method of frond agitation. Agitation serves many roles including keeping negatively buoyant fronds in suspension, mixing nutrients, improving the rate of nutrient absorption, and allowing fronds to periodically absorb sunlight while preventing overexposure (Craigie & Shacklock, 1995). Different modes of agitation include air sparging, water jets, and paddle wheels, but air sparging is

the best technique for *Chondrus* (Craigie & Shacklock, 1995). Air sparging is ten times more efficient and trouble free in comparison with paddle wheels in tank cultivation of *Chondrus* (Bidwell *et al.* 1985).

Pests and Weeds

Many grazers and epiphytes have been reported to severely impact *Chondrus* production. Grazers such as amphipods, isopods, and snails are known to graze on the apical meristems of the fronds and cause fragmentation and reduced productivity. Ways to deal with these grazers include insecticides, manually removing (in the case of snails) or introducing fish predators to consume the herbivores (Craigie & Shacklock, 1995). However, it is important to note that grazers have been reported to be beneficial in keeping the epiphytic seaweed populations suppressed (Craigie & Shacklock, 1995; Bidwell *et al.* 1985).

Epiphytes in *Chondrus* cultures include diatoms, filamentous brown seaweed (*Ectocarpus* spp.), green seaweed (*Ulva* spp.), and the green endophyte *Acrochaete operculata*. If populations of epiphytes get to be 10% of the population the crop of *Chondrus* may be compromised for commercial purposes (Craigie & Shacklock, 1995). For *Ectocarpus* spp. maintaining temperatures above 15°C (Craigie & Shacklock, 1995) or increasing the fertilizer levels (Bidwell *et al.* 1985) can impair growth. Another way to manage epiphyte populations is to maintain high *Chondrus* densities of 8-12 kg m⁻² (Bidwell *et al.* 1985).

Diseases

Two diseases have been reported to affect cultures of *Chondrus*. The first disease is caused by the oomycete *Petersenia pollagaster* and results in moribund and decaying apices on fronds. Since this disease is caused by a parasitic fungus, it can be treated using the common detergent sodium dodecyl sulfate, which at low concentrations will not harm *Chondrus*. The second disease results in randomly affected cells, which die and form small green colored spots which eventually become holes in the fronds of the plants. The pathogen responsible for this infection remains unidentified (Craigie & Shacklock, 1995).

Stocking Density

Typically with increased air agitation rates, the stocking density of the cultures can be increased without negative impacts. Bidwell and colleagues (1985) considered a low loading density to be between 4-6 kg m⁻² for *Chondrus* and a high loading density to range from 8-12 kg m⁻². They also reported that while the growth of individual fronds was slower at higher loading densities, the overall dry weight and carrageenan production was higher. As mentioned before, high loading densities can also help inhibit the growth of epiphytes (Bidwell *et al.* 1985).

Nutritional Requirements

The major macronutrients that all seaweeds require for growth are nitrogen, phosphorus, and carbon. *Chondrus* also has requirements for elements that are normally present as dissolved salts in seawater including iron, copper, manganese, zinc, cobalt, chlorine, molybdenum, magnesium, calcium, potassium, sulfur, oxygen, and hydrogen. When growing *Chondrus* with rapid growth rates, several limiting nutrients become obvious (Craigie & Shacklock, 1995).

Carbon is required for photosynthesis and *Chondrus* has the ability to rapidly absorb carbon from the water. As carbon is absorbed, the pH of the water increases, resulting in a decrease or stop in photosynthesis. Supplying carbon through bubbling helps to maintain optimal pH while supplying additional carbon to the fronds (Craigie & Shacklock, 1995). *Chondrus* grown in recirculating IMTA systems will not require the addition of carbon. In those systems, the fed crop (i.e. fish or shrimp) produces carbon dioxide that can drive photosynthesis in *Chondrus*.

Nitrogen is a major limiting factor in seaweed cultivation and when nitrogen becomes limiting *Chondrus* fronds become visibly pale and even bleached. The carrageenan content is inversely related to nitrogen in *Chondrus* tissue (the "Neisch effect"). Depleting nitrogen at the end of the culture period is a strategy to increase the flow of the products of photosynthesis into carbohydrates and lipids. *Chondrus* can sustain good growth when

nitrogen is supplied as either ammonium (NH_4^+) or nitrate (NO_3^-) typically as ammonium nitrate (NH_4NO_3) and/or ammonium phosphate monobasic [$(\text{NH}_4)\text{HPO}_4$] fertilizer to attain an initial concentration of 1 mM nitrogen in culture tanks (Craigie & Shacklock, 1995). *Chondrus* grown in recirculating IMTA systems will not require the addition of nutrients. In these systems, the fed crop (i.e. fish or shrimp) produces inorganic waste including nitrogen that supports the growth of the extractive crops (i.e. seaweeds).

Phosphorus deficiency results in lighter color and reduced productivity in *Chondrus* cultures. The phosphorus needed for the culture is typically achieved through the addition of ammonium phosphate monobasic $(\text{NH}_4)_2\text{HPO}_4$ fertilizer for a maximum pulse of 0.1 μM (micromolar) phosphate. A lag period in growth is typical after the addition of phosphorus (Craigie & Shacklock, 1995).

In tank culture of *Chondrus* addition of trace metals is unnecessary if a high flow rate is maintained and natural seawater is used. Occasionally, the addition of iron in a chelator form such as EDTA (ethylenediaminetetraacetic acid) has been required (Craigie & Shacklock, 1995).

In terms of when to add nutrients to cultures, Bidwell *et al.* (1985) reported that pulse fertilizing at a rate of three times per week gave better production than one weekly addition. They further suggested adding the nutrients during a period when there is no flushing to avoid losing them (i.e. if you flush your system during the day you should add the nutrients during the night and vice versa). Craigie (1990) reported that pulse fertilizing was also an effective strategy for the control of epiphytes. The correct amount of nitrogen and phosphorus are added to the culture by mixing the necessary weights of (NH_4NO_3) and $[(\text{NH}_4)\text{HPO}_4]$ fertilizers together and adding them to the culture tanks until a 1 mM (millimolar) nitrogen and 1 μM phosphate concentration are achieved. To calculate molar concentrations, first determine the molecular weight of the chemical, which should be indicated on the packaging information. The molecular weight is the grams of the compound added to 1 liter of water to achieve a 1 molar (M) concentration. Calculate the grams needed to achieve the desired concentration based on the amount of water in the system (1 millimolar, mM, is 10^{-3} molar and 1 micromolar, μM , is 10^{-6} molar). The amount of each fertilizer necessary to meet the proper concentrations will vary depending on the size of the tank (Craigie & Shacklock, 1995). Craigie & Shacklock (1995) suggests that an optimum nitrogen-to-phosphorus ratio of 15:1 is appropriate for *Chondrus* cultures. A further study by Craigie and colleagues (1999) reported that nitrogen to phosphorous ratios of 20:1 N: P (max 0.55 mM NH_4) resulted in ammonium toxicity and growth suppression.

Tank Design

Tank and system design can be extremely complex, but there are some general aspects that have been reported for *Chondrus* cultivation. In the past, tanks made from concrete and dehydrating agents were used to cultivate *Chondrus*. These tanks require occasional scrubbing to keep them clean and this process can be simplified if the tank is lined with a vinyl skirt, which can be dried out when epiphytes (other seaweeds and/or microalgae) grow. Scrubbing tanks can be a physically important labor cost.

The most important factor when designing a tank is the water depth (Bidwell *et al.* 1995). With high plant densities, increasing depth leads to a longer lag period between sunlight exposures for plants. The time can be shortened by increasing the amount of pipes supplying air for agitation, but a depth greater than 90 cm increases the construction costs substantially (Bidwell *et al.* 1985).

Although production of *Chondrus crispus* has been successful at Acadian Seaplants, LLC (Charlesville, Nova Scotia, Canada) using the above described tank systems, production of crops has been mainly limited to the natural growing period. This is due to the fact that tank systems are outdoors and are subject to freezing during the harsh Canadian winters (Craigie & Shacklock, 1995). Yield (wet weight) and carrageenan content during the natural growing period, from April through August, account for over 67% of the yield for the entire year (Bidwell *et al.* 1985). Due to the expense of providing lighting for indoor culture in temperate zones this method of culture has persisted because of the small market for *Chondrus* (Craigie & Shacklock, 1995).

Open Water Cultivation

The high operation and labor costs of cultivating *Chondrus* in land-based tank systems has led to studies on culturing *Chondrus* in open water. *Chondrus* grown off of Prince Edward Island, Canada had growth rates during the growing season ranging from 2-4% per day. Loss of biomass in the study from fragmentation led to a lower growth rate. These growth rates are less than that of *Kappaphycus alvarezii* and *Euchema* spp., the other major carrageenan producing red seaweeds, but the reduced growth rates were compensated by the high carrageenan yields, typically between 58.1 and 71.0% of the dry weight. Therefore, transplanting wild *Chondrus* to grow-out sites during the summer months may be an economical way to culture this valuable carrageenophyte and compete with the other carrageenan producing seaweed on the market (Chopin *et al.* 1999). Furthermore, if the purpose of culturing *Chondrus* is as a bioextractive and secondary crop, then growing *Chondrus* in mesh bags in the open water becomes more appealing (Figure 5.11).

Chondrus has also been cultivated in the temperate Pacific Ocean waters off of the Baja California peninsula. *Chondrus* fronds have to be acclimated to warmer water temperatures (between 18-22°C) and then can be placed in mesh bags stocked with seaweed on offshore long lines.

Growth in these systems averaged only 1.31% per day, which is much less than the rates shown in the cooler Canadian water. This low growth rate was attributed to three separate events. First, a winter storm dramatically decreased biomass. Second, the farm was inundated with loose giant kelp (*Macrocystis*) for a period of time which caused shading of the *Chondrus*. Lastly, an increase in water temperatures above 23°C due to El Niño significantly decreased the growth of *Chondrus*. The cost of farming *Chondrus* in warmer waters exceeds the cost of farming *Euchema* spp. but the farmed fronds remain much cleaner than wild fronds and the capital investment to farm *Chondrus* offshore is much less than that required for a land-based farm (Zertuche-González *et al.* 2001). Because capital investment is always a major hurdle in aquaculture operations, cultivating this economically important species of seaweed in open water systems may be advantageous when considering the additional benefits of nutrient removal and environmental sustainability.



Figure 5.11. *Chondrus crispus* in mesh bags for open water aquaculture (Courtesy of NOAA)

Chapter 6. Nori



Figure 6.1. *Porphyra/Pyropia*

The red seaweed *Porphyra* and other closely related genera such as *Pyropia*, known collectively by the Japanese name nori, are of particular interest for use in aquaculture (Figure 6.1). Nori is the most economically valuable maricultured seaweed in the world and serves as a major source of food for humans (Yarish *et al.* 1998). Asian production of nori was over 1.01 billion metric tons wet weight in 2003, valued at USD \$1.8 billion (He & Yarish, 2006; Figure 6.2). Since *Porphyra/Pyropia* is also a candidate for substitution of finfish meal due to its high protein and unsaturated fatty acid content, it has great potential as a secondary crop in Integrated Multi-Trophic Aquaculture (IMTA) systems (Walker *et al.* 2009). IMTA represents an environmentally sustainable method of aqua-

culture by properly coupling the waste production of fed species (e.g. finfish) with the extractive capabilities of other crops (e.g. seaweeds/shellfish; Neori *et al.* 2007). Growing *Porphyra/Pyropia* in land-based recirculating IMTA systems is of particular interest and is the basis for this chapter.

The main reason *Porphyra* and *Pyropia* are candidates for IMTAs is due to their ability to take up inorganic wastes out of the environment. Finfish effluent is rich in inorganic nitrogen and phosphorus, which has been implicated in nutrient loading of coastal waters, leading to harmful algal blooms (Neori *et al.* 2007). Inorganic nutrients are required for the growth of seaweed and can be taken up by *Porphyra* and *Pyropia* with very high efficiency (Carmona *et al.* 2006). Under typical fish farm nutrient loading conditions, Carmona and colleagues (2006) showed 96% and 73% removal of nitrogen and phosphorus, respectively, by *Porphyra/Pyropia*. Those species tested included the Northwest Atlantic species *Porphyra purpurea*, *Porphyra umbilicalis*, and *Pyropia leucosticta*. Kraemer & Yarish (1999) reported that *Porphyra purpurea* and *Porphyra umbilicalis* had higher photosynthetic rates than the sub Asian species *Pyropia yezoensis* making them better candidates for IMTA systems due to their potential ability to tolerate crowding and shading at the commercial scale. The ability of Northwest Atlantic species of *Porphyra/Pyropia* to take up inorganic nutrients, their potential uses as secondary crops, and the fact that most fish aquaculture in the Northeast United States revolves around cold/temperate water finfish all promote the development of local *Porphyra/Pyropia* species for IMTA systems.

Biology

Porphyra is a genus of foliose red algae in the family Bangiaceae. It is a large genus, with over 100 species reported worldwide in temperate and cool regions of the globe (Yoshida *et al.* 1997). Recently, this genus has undergone a major taxonomic revision, resulting in the splitting of *Porphyra* into 8 genera based on molecular evidence (Sutherland *et al.* 2011). Unfortunately, most species of *Porphyra* cannot be identified morphological and DNA sequence analysis has to be performed by the grower or a lab equipped to do so in order to get positive species identification. With the splitting of the genus *Porphyra*, it is now difficult to identify even the genus that specimens belong to morphologically. For the remainder of this manual, the term nori will be used to refer

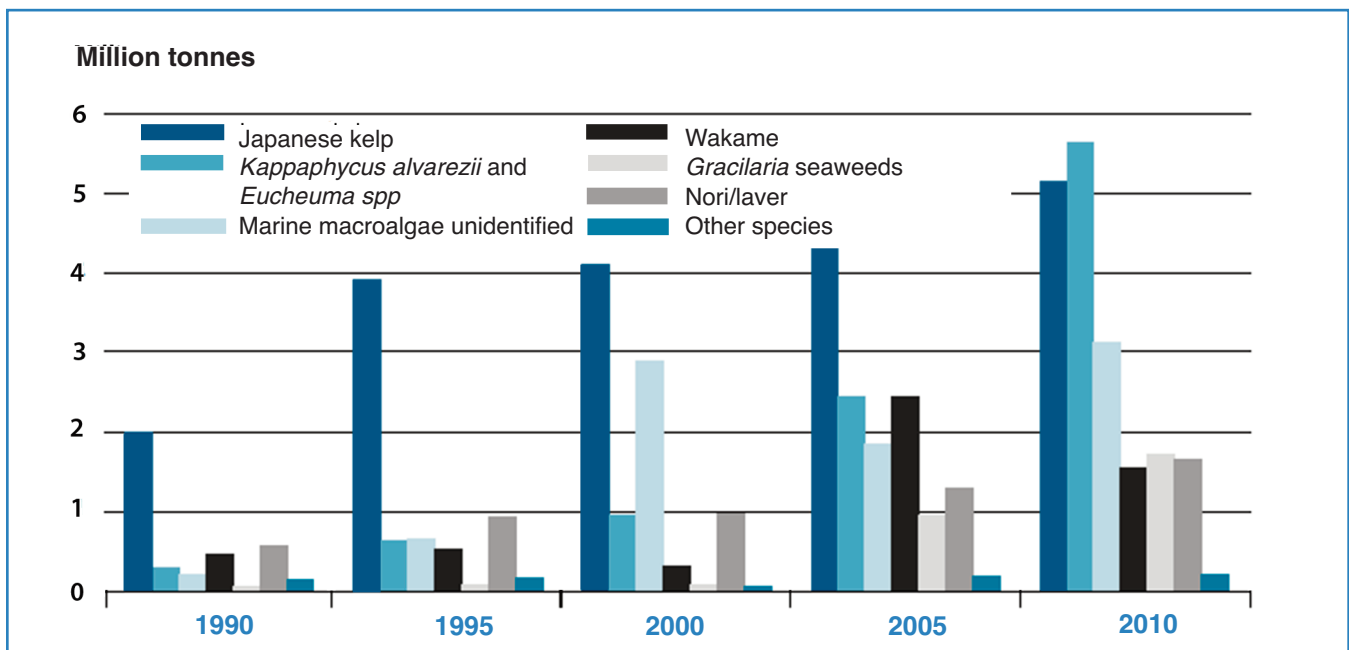

Figure 6.2. Worldwide production of several economically important seaweeds including nori/laver. Courtesy of FAO Review of the State of World Aquaculture 2012.

collectively to all of the economically important species in the eight genera that used to be known as *Porphyra* (this includes species in the genus *Pyropia* and *Wildemania*, in particular). The type species for *Porphyra* is *Porphyra purpurea*. For future reference, the sub Asian species *Porphyra yezoensis* and the Northwest Atlantic species *Porphyra leucosticta* are now in the genus *Pyropia*.

The main New England species of interest are *Porphyra purpurea*, *Porphyra umbilicalis*, and *Pyropia leucosticta*. All three of these species are found along the Northwest Atlantic coast from the Canadian Maritimes to Long Island Sound (Klein *et al.* 2003). *Porphyra umbilicalis* is found throughout the year and has only been observed to reproduce asexually in the Northwest Atlantic, making it particularly advantageous for integration into aquaculture (Blouin *et al.* 2007). *Pyropia leucosticta* is found in the winter and spring, frequently as an epiphyte on *Chondrus crispus*, *Fucus vesiculosus*, and *Polysiphonia lanosa* (Chopin *et al.* 1999). *Porphyra purpurea* gametophytes are monoecious (i.e. both male and female are represented on a single blade), with the female and male parts distinctly separated by a straight line (Lu & Yarish, 2011). The microscopic sporophyte phase (conchocelis) is typically observed during the spring and summer since studies have shown that neutral to long day lengths are required for conchosporangia formation (Conway & Cole, 1977). All three of these species are found in the intertidal zone and can be easily collected during low tide.

Seaweeds, such as nori, that inhabit the intertidal zone are subject to a variety of environmental stresses including solar irradiance, temperature and desiccation (Sampath-Wiley *et al.* 2008). Vertical zonation patterns in the intertidal zone are often reflective of the environmental tolerance and competitive dominance of species, with more tolerant and less dominant species inhabiting the upper intertidal. *Porphyra umbilicalis* is typically located in the high intertidal zone, and *P. purpurea* and *P. leucosticta* in the mid to high intertidal zone in the Northwest Atlantic (Figure 6.3).

Pyropia leucosticta is an annual (blades survive only one growing season) that is found reproductive throughout the year (Brodie & Irvine, 2003). A wide variety of colors with great morphological variations ranging from almost circular to elongate are observed in *P. leucosticta*. This species is epiphytic in its blade phase and the microscopic conchocelis phase has not been reported in the wild although agamospores (spores formed through cleavage that are not fertilized and grow into conchocelis), neutral spores (spores formed through cleavage that are not fertilized and grow into blades), and archeospores (spores formed by differentiation of a

***Porphyra purpurea******Porphyra umbicalis******Pyropia leucosticta***

Figure 6.3. Species of nori from the Northwest Atlantic

vegetative cell that are released as a single spore per cell and develop into blades) are not known in this species (Brodie & Irvine, 2003).

Similarly to *P. leucosticta*, agamospores, neutral spores, and archeospores are not known in *P. purpurea* either (Brodie & Irvine, 2003). The blade form of *P. purpurea* is found throughout the year, although they are more common in the summer months. Reproductive structures are also found year round with a peak in August and September. Both *P. purpurea* and *P. leucosticta* are monoecious with both female and male gametangia appearing on a single blade. In *P. purpurea* male and female gametangia are clearly separated with the male section appearing pale yellow and the female section appearing as a dark red region of the blade (Brodie & Irvine, 2003).

Figure 6.4. *Wildemanian amplissima*

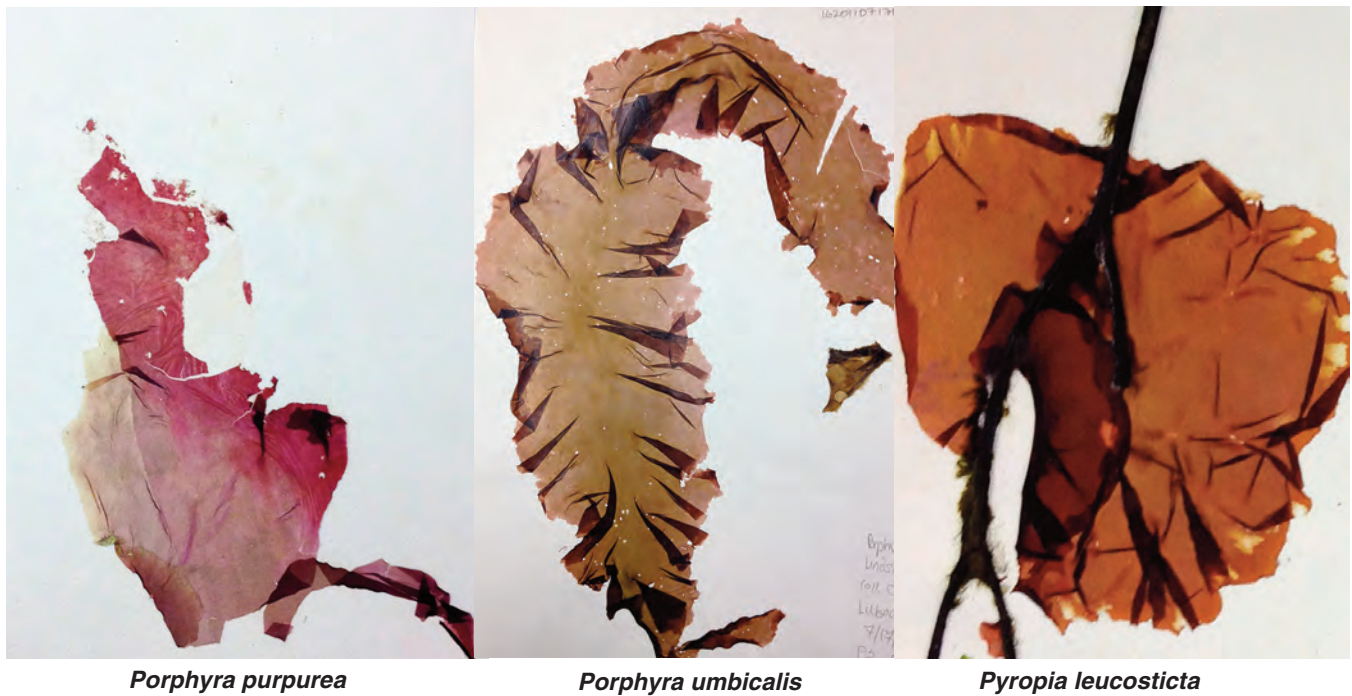
Porphyra umbicalis is typically dioecious (separate male and female blades) and males can be identified by pale yellow margins while the female blades have red colored margins (Brodie & Irvine, 2003). In the Northwest Atlantic, *P. umbicalis* does not reproduce sexually and propagates through neutral spores or agamospores, which develop into new blades (rather than the conchocelis phase). Blades are epilithic, growing on bedrock, boulders, and other hard substrata on both exposed and sheltered shores (Brodie & Irvine, 2003).

Another species of local nori that has been gaining interest is the subtidal species *Wildemanian amplissima* (Figure 6.4). *W. amplissima* is monoecious with the blade form occurring epiphytically on a variety of algae and shells down to 15 m in depth and colors ranging from pallid pink to crimson red (Brodie & Irvine, 2003). Asexual reproduction in the form of neutral spores, archeospores, or agamospores has not been reported in this alga and the geographical range of *W. amplissima* spans from Arctic Canada to New Hampshire (USA) in the Northwest Atlantic,

Greenland, and Arctic Russia to the British Isles and Baltic Sea (Brodie & Irvine, 2003). The growing interest in this local species spurs from the fact that this alga can grow to a considerably larger size than other species of nori, with documentation of individuals up to 6 feet in length (Brodie & Irvine, 2003).

Nori has a heteromorphic alternation of generation (i.e. the generations are different in shape and size), alternating between the foliose gametophyte blade (male/female) and the microscopic filamentous sporophyte known as the conchocelis phase. The conchocelis phase bores into oyster shells and upon maturation releases conchospores, which grow into blades (Sahoo & Yarish, 2005). Conchocelis can also be cultured “free-living” in laboratory settings (He & Yarish 2006). The life history of *Porphyra umbilicalis* was first characterized by Kathleen M. Drew in 1949 when she noted that the previously described “*Conchocelis rosea*” was not a separate species but simply a phase in the life cycle of *P. umbilicalis*. This discovery led to the establishment of nori seaweed aquaculture industry in Japan where Kathleen M. Drew is known as the “Mother of the Sea”.

Male gametes (sperm), form in the spermatium, which can be found on the male section of the blade (monoecious) or on the male blade (dioecious). Once released, the sperm fertilize the egg in the female carpogonia. The sperm attaches to the trichogyne (hair-bearing cell) of the female carpogonia and the nucleus of the sperm moves into the female cell and fuses with the female nucleus. Once the egg is fertilized, cell division through mitosis occurs resulting in a zygotosporangium with mature zygotospores. These spores will be released into the environment, settle on suitable substrata (typically oyster or other shellfish shells), and develop into the sporophyte generation of nori known as the conchocelis. The conchocelis bores into shells and can be recognized as a red ‘fuzz’ as it grows vegetatively. When triggered, the conchocelis will form fat filaments indicating the presence of mature conchosporangium branches where meiosis occurs, resulting in four identical haploid spores. These conchospores will be released and settle on suitable substrata (usually rocks (epilithic) or other algae (epiphytic)) where they will germinate and grow into new haploid gametophytic male/female blades, thus completing the life history of nori (Figure 6.5).

Asexual reproduction is common in nori. In the gametophyte phase, neutral spores, endospores, or archeospores are produced in the carpogonium through mitosis and will develop into the gametophytic blade phase. Endospores are characterized by mitotic division resulting in unequal sized, irregular shaped spores. Neutral spores are the result of mitotic division resulting in equal, regularly shaped spores (although the number produced is species specific). Archeospores (old term “monospores”) are large spores with only one produced per female cell. Similarly, the conchocelis phase can also produce archeospores (in a different structure than the conchosporangium) that will develop into more conchocelis. In the Northwest Atlantic, *Porphyra umbilicalis* reproduces from blade to blade through neutral spores and has never been documented to go through the sexual reproduction cycle although it is common in *P. umbilicalis* in the Northeast Atlantic.

Another form of asexual reproduction in nori is through agamospores. Agamospores are formed through mitosis in the carpogonium but are unfertilized spores that will develop into haploid conchocelis phase. Kornmann and Sahling (1991) reported the occurrence of agamospores in both *P. linearis* and *P. lacinata* from Helgoland. In cross-section, agamospores can be distinguished from zygotospores by the absence of the trichogyne, the absence of the halo indicating fertilization, and typically the division results in fewer large spores. After the conchocelis phase is formed from agamospores, the conchocelis (being haploid) produces conchosporangial filaments. These filaments will again produce agamospores that will be released and develop directly into haploid blades/gametophytes (no meiosis as it is already haploid). Advantages of asexual reproduction include that it maintains the genetic identity of the phenotype and asexual reproduction through agamospores has the added advantage of the conchocelis phase. According to Brodie and Irvine (2003) the conchocelis phase is assumed to afford some advantages through different tolerances and avoidance of competition, grazing, and intertidal stresses (conchocelis survives on shells in the subtidal). The major disadvantage of asexual reproduction is the lack of genetic diversity (no genetic recombination). In the event of an ecological or biological stress, the organism will have less resilience.

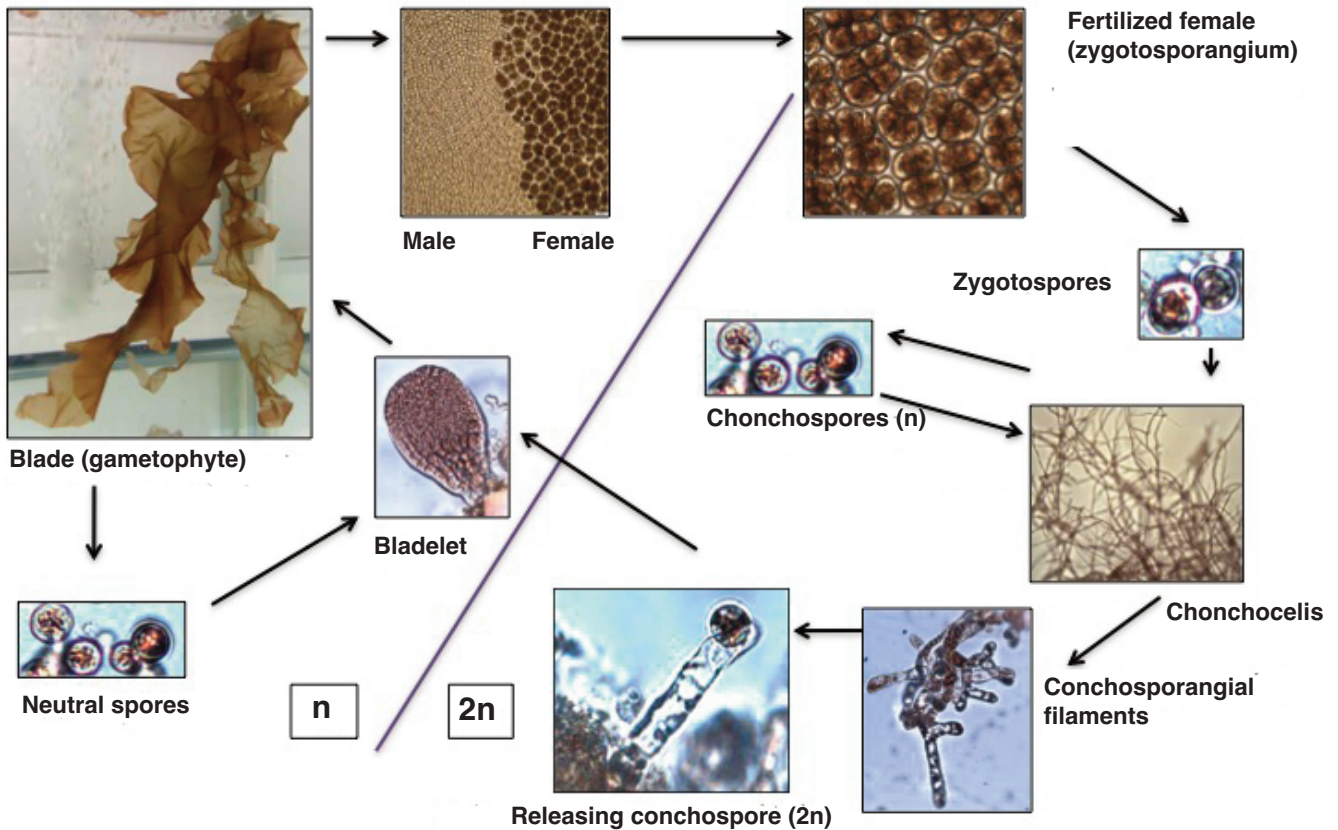

Figure 6.5. The life history of nori.

Cultivation

Traditional cultivation methods in Asia

Cultivation of nori began in the 17th century in Asia (namely China, Japan, and Korea; Sahoo & Yarish, 2005). In those times, farmers used natural seeding of artificial substrata to cultivate the valuable seaweed. It wasn't until after the completion of the life history of nori by Kathleen M. Drew in 1949 that modern techniques for nori cultivation were invented. Today, there are four major steps to the cultivation of nori: culture of the conchocelis phase, seeding of nets with conchospores after inducing their release, nursery rearing of nets seeded with small bladelets, and harvesting of fully grown blades (Sahoo & Yarish, 2005; Figure 6.6). The major nori species that are currently cultivated in Asia are *Pyropia yezoensis* and *Pyropia haitanensis*.

The culture of the conchocelis stage begins in the spring (March/April) in Asia with the seeding of sterile mollusk shells or artificial shells from fertile blades (Sahoo & Yarish, 2005). Fertile blades are collected from seed stock or wild populations, dried out to induce stress, and re-immersed in seawater, resulting in the release of zygotospores. The re-immersion typically takes place in tanks that are stocked with shells (remember, red algal spores are non-motile and typically settle onto suitable substrata quickly). Once the spores are settled, conchocelis will grow vegetatively throughout the summer under low light (25-50 $\mu\text{mol photons m}^{-2} \text{s}^{-1}$) at 16:8 light: dark and around 23°C (Sahoo & Yarish, 2005).

Conchospore release is induced in the fall, when ocean water temperatures are around 23°C (Sahoo & Yarish 2005). Conchospore release is induced by stirring the water, lowering the water temperature (18-20°C), or aerating the cultures using compressed air. Following the release of conchospores, nets are seeded in several



Figure 6.6. Tanks used for conchocelis culture (left) and a closeup of shells used for conchocelis culture (right).

ways. Indoor seeding is typically done using a rotary wheel, with nets stacked on top of one another and fixed to the wheel (Figure 6.7). The wheel is then slowly rotated in the water where the spores have been released. Conchospores are buoyant and will float to the surface of the tank and adhere to the net when they come into contact with it. Seeding can also be accomplished by suspending nets on the surface of the water and spraying them with water containing conchospores (Sahoo & Yarish, 2005).

Once the nets are seeded, they are transferred in stacks to nursery cultivation in the sea (Sahoo and Yarish, 2005). Nets in the nursery stage are raised out of the water daily and allowed to dry to prevent epiphytes and other fouling organisms. Once blades have reached a critical size (2-3mm) they are either transferred to farm sites or dried out to around 20% of their water content and frozen for later use at -20°C . There are three main methods to cultivating nori: floating raft, semi-floating raft, and fixed pole, with the former designed for deeper waters and the latter for shallow intertidal habitats (Sahoo and Yarish, 2005).



Figure 6.7. Indoor net seeding in Korea with conchospores using rotary wheels.

After outplanting, blades of nori are allowed to grow for 40-50 days and then they are harvested for the first time (Sahoo and Yarish, 2005). At this point, the blades are typically between 15 and 30 cm in length. After the first harvesting, the remaining blades are harvested again after 15-30 days. Each net can be harvested several times in a growing season (Figure 6.8). After the crop is harvested, it is washed, dried, cut into small pieces, and pressed by special machinery in order to make rectangular sheets for use in sushi or to make products for other markets (Sahoo and Yarish, 2005).

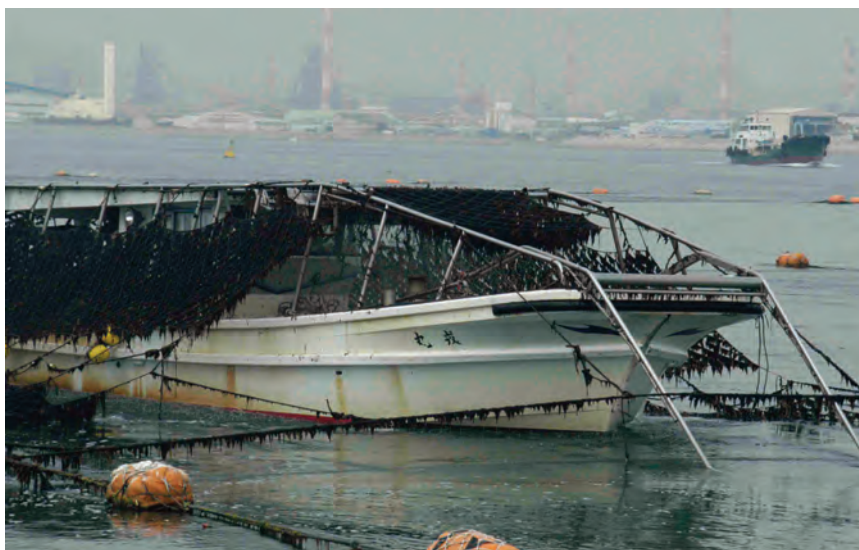

Figure 6.8. Mechanical harvesting of nori nets in Japan.

Growing conditions for New England nori

The optimal temperature for growth of most species of nori is between 10-17°C (Israel, 2010). When temperatures reach 18°C and above, the biomass yields of cultured nori drop dramatically, with almost no growth observed above 20°C. In Asian latitudes where nori is grown on nets in the sea, outplanting of nets begins in the autumn months when temperatures are in the low 20's (°C). The water cools during the outplanting and the optimum temperature for nori nets in the sea is between 8-10°C. However, the optimum temperature in laboratory settings has been shown to be 15°C (Israel, 2010).

Many studies have investigated the optimum conditions for growth of nori, both locally and worldwide. Important environmental factors include temperature, photoperiod (the amount of light and dark in a day), and light level. Table 6.1 shows a summary of the optimum temperatures and photoperiods for growth of four local species of nori along with the corresponding growth rate and source of the data.

Table 6.1. Summary of optimum growing conditions for local nori species of interest. Data shown is from indicated source or from investigations undertaken at the University of New Hampshire.

Species	Temperature (°C)	Photoperiod (Light: Dark)	Growth Rate (% day-1)	Source
<i>Porphyra umbilicalis</i>	10-15* 10**	16:8> 12:12> 8:16	10-12%*	*Blouin <i>et al.</i> 2007; **Kim <i>et al.</i> 2007
<i>Pyropia leucosticta</i>	10-15*	16:8> 12:12> 8:16 8:16**	10-13%*	*Kim <i>et al.</i> 2007; **Sidirelli-Wolff 1992
<i>Porphyra linearis</i>	10*	12:12*	16%*	*Kim <i>et al.</i> 2007
<i>Wildemania amplissima</i>	20*	12:12*	10%*	*Kim <i>et al.</i> 2007

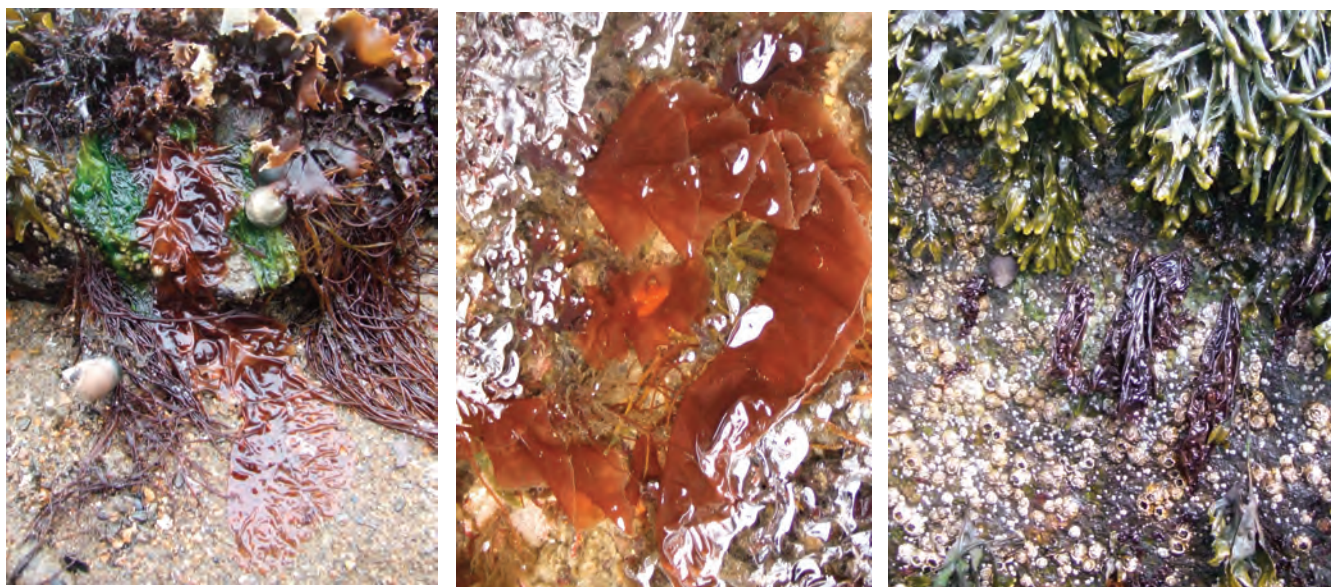

Figure 6.9. *Nori* in the intertidal. *Nori* can be found growing on rocks (left), epiphytically on other algae (middle), or epilithically on concrete pilings (right)

Processing Wild Collected Material

Nori can be easily collected during low tide at most rocky shore coastal environments. *Nori* can be found growing on a variety of substrates including rockweeds, concrete pilings on piers, and rocks throughout the intertidal zone (Figure 6.9). Often several species of *nori* can be found at a single site and molecular verification of species identity will have to be performed after spore isolation as this process takes at least one week.

After samples have been located, they should be placed in Ziploc® bags without water and placed on ice for transport to the lab. After arrival at the lab, samples should be kept in the refrigerator and processed as soon as possible. Using a dissecting microscope, a 2 x 2 mm reproductive portion of the blade (margin) can be excised using a sterile razor blade. It is very important during this process to eliminate as much non-reproductive tissue as possible in order to reduce the chance of contamination. Reproductive portions of the blade can be determined by locating mature cells on the edges of the blade, which appear as red, square shaped cells divided into four sections (Figure 6.10). After the reproductive tissue has been excised, it should be rinsed in sterile seawater several times and cleaned with sterile cotton balls if necessary to remove all epiphytes. The clean reproductive material can then be wrapped in damp, sterile cheesecloth or paper towel and placed in the dark at 4°C overnight (i.e. in the refrigerator).

The following morning, the sections should be removed and placed in sterile shallow Petri dishes with seawater at 10°C and 10-200 $\mu\text{mol photons m}^{-2} \text{s}^{-1}$ light intensity. After approximately one hour, samples should be checked for spore release using a dissecting microscope. Spores appear as small, round, red spheres or balls and ruptured cells on the edges of the reproductive material, which appear transparent and empty, are an indication of spore release. If spores are not visible, check the cultures every hour until release occurs. If spores are present, isolation should occur immediately.

Spore Isolation

For spore isolation, autoclaved Pasteur pipettes are heated above a flame and using tweezers, the tip of the pipette is pulled long and thin during heating. This allows for the ability to pick up individual spores rather than groupings of spores. Spores are picked up using vacuum pressure created by placing the thumb over the end of the pipette to seal it, locating an individual spore under the dissecting microscope, carefully placing the pipette adjacent to the spore while looking through the microscope and slowly releasing the thumb from the end of the pipette to allow the spore to be collected in the pipette. The spore should be transferred into a single well of a 24 or 12-well culture plate (each well holds approximately 3.3 and 6.6 mL of sterile Von Stosch Enriched seawater, respectively). The spore is expelled from the tip by gently blowing until small bubbles of air are produced in the well indicating that the pipette is empty. The procedure should be repeated until the desired numbers of spores are isolated from each sample. An alternative method is to isolate individual spores into sterile shallow Petri dishes containing sterilized pieces of glass microscope slides. The spores will settle onto the glass surface

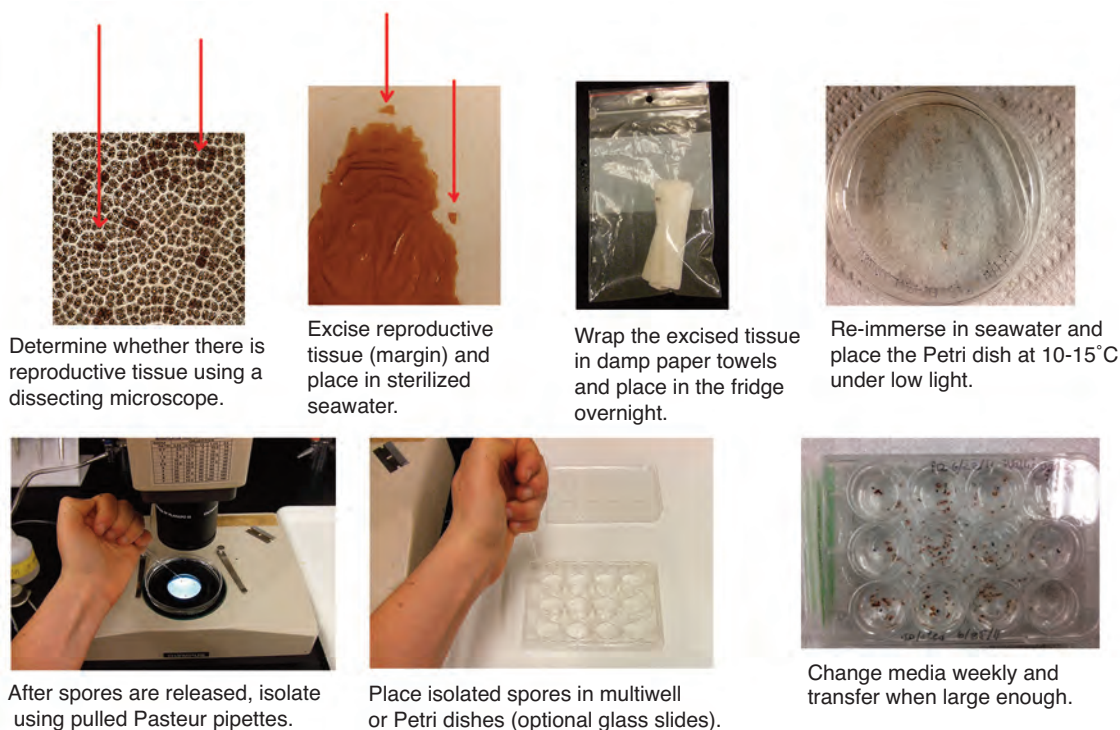

Figure 6.10. Spore isolation protocol for nori.

and grow allowing for ease of transfer and manipulation. All materials used in the processing of blades and isolation of spores should be autoclaved or flamed to ensure sterility. Multiwell plates of spores can be maintained at 10-15°C and 10-200 $\mu\text{mol photons m}^{-2} \text{s}^{-1}$ light with a photoperiod of 12 hours of light and 12 hours of dark (i.e. neutral day).

After spores have grown into blades of visible size (at least 1 mm), blades can be transferred into Erlenmeyer flasks or other culturing containers (i.e. glass carboys) to enable faster growth. Air is supplied to each flask using an autoclaved aeration set-up connected to an air pump. All flasks should have bacterial air filters to help maintain unialgal cultures. As the blades grow, they should always be gently agitated by air and supplied with fresh sterile enriched seawater weekly. Once they reach an appropriate size for the desired use, they can be transferred into tank systems of various sizes.

If spores develop into the microscopic sporophyte phase, or conchocelis, they can also be transferred into flasks and aerated but should be maintained at lower light (less than 50 $\mu\text{mol photons m}^{-2} \text{s}^{-1}$). To vegetatively grow conchocelis, an individual spore, recognized as a small fuzzy red ball of filaments, is transferred into a flask. After the ball grows in size, it is cut up into several pieces using a sterile razor blade. Those new pieces will continue to grow and can be cut up again. This process continues in order to obtain the desired biomass of conchocelis. The vegetative growth of conchocelis can be induced under certain culturing conditions. For *Pyropia leucosticta* investigations at the University of New Hampshire have indicated that growing conchocelis under low light (<50 $\mu\text{mol photons m}^{-2} \text{s}^{-1}$) at 10-15°C will encourage vegetative growth of conchocelis for about 8 weeks. After that time, conchosporangial filaments are formed and spores will be released 6-10 weeks later, growing into blades.

Nutrient Media

After sterilization, Von Stosch Enrichment Solution (VSE) must be added to the seawater. For the cultivation of kelp, many people prefer Provasoli's; however red seaweeds seem to have greater success in Von Stosch. There are 6 stock solutions that are made up separately and then filter sterilized and stored for future use. Full strength Von Stosch will require 1 mL per 1 L of seawater and higher concentrations can be made if large quantities are required (see Appendix). Changing the seawater weekly is required in order to maintain all cultures. For integrated aquaculture purposes, consider replacing the nitrogen source from nitrate to ammonium, the product of fish metabolism.



Figure 6.11. *Porphyra* cultures in a cold room at 15°C

Strain Selection

When cultivating an alga, the choice of species depends on the product to be marketed, whether for human consumption, cosmetics, or pharmaceuticals. Once the species is chosen, a strain must be selected through a screening process. This process must take into account many factors including the performance of the alga in the local environment and a gradient of responses that the alga has to environmental factors (Craigie, 1990). If the cultivation of the alga is to occur in the ocean environment, then specific criteria must also be met when selecting a site.

As mentioned previously, nori is an alga of particular interest for integration into recirculating IMTA systems. Different species of nori may be better suited for different secondary crop purposes. For example, nori that is marketed as a human food product is graded based on its pig-

mentation. Red algae have unique photosynthetic pigments (cyanobacteria have them as well) known as phycobilins. There are a variety of phycobilins that absorb different wavelengths of light, but the main three give blades either a blue, red, or greenish tint. It is the ratio of these phycobilins to one another that ultimately results in the color of the blades. The sub Asian nori species cultivated frequently, *P. yezoensis*, is known for its deep red color, indicating high phycobilin content, and those blades with the deepest color command the highest market prices. Phycobilins are significantly affected by nitrogen concentrations because they are used as nitrogen storage compounds in red algae. Our local species that is similar in color, morphology, and thickness to *P. yezoensis* is *P. leucosticta*. Therefore, *P. leucosticta* may be the best choice for a secondary crop marketed as a human food product.

If a fishmeal substitute is desired, then choosing a species with high protein content would be best. Studies have shown that *P. umbilicalis* can be successfully integrated into finfish diets, replacing up to 30% of fishmeal with no negative growth effects (Walker *et al.* 2009). Furthermore, *P. umbilicalis* only reproduces asexually in the Northwest Atlantic, making it easier to maintain a constant seed stock. Ultimately, the species of nori chosen will be based on what the goal for a secondary aquaculture product is.

Culture System

To start a culture system for nori there are several items that you will need in addition to basic laboratory supplies including a supply of sterile seawater for weekly water changes, a cold room kept between 10-15°C (alternatively you can use a chiller and create a water bath to put your beakers into if a cold room is not available with an external pump to circulate the water), pumps for supplying aeration, and a source of lighting for photosynthesis. Chillers should be used in rooms that are already relatively cool so that the chiller does not become overworked. Standard lighting in rooms is not adequate for optimal seaweed growth. However a fluorescent light fixture with fluorescent lights should work adequately depending on the number of cultures and tanks you are using. A light meter will help you to adjust the levels appropriately (see Table 1).

Nori culturing can be done on many different scales. In a laboratory setting, blades are transferred periodically into larger containers according to growth rate and size. In order to seed a large tank, as many small blades as possible should be produced and then added to the tank in large quantities once they are big enough to not get sucked into the water outflow (~1 cm in most aquaculture tanks depending on the screen on the outflow). In order to produce large quantities of small blades, less big lab equipment is needed.

During the spore isolation process, many trays of spores should be isolated, as well as several sterile Petri dishes containing 100-200 spores each, which serve as back-up cultures. After the blades grow to a size large enough to transfer to an aerated beaker they can be gently scraped off of the bottom of the Petri dish using a sterile razor blade or tweezers. Care should be taken to avoid dislodging any plastic material from the bottom of the Petri dish (if you are using sterile plastic dishes) as the transfer of this material into flasks will often encourage contamination. The small blades can then be rinsed from the Petri dish into appropriate sized Erlenmeyer flasks (i.e. 1 L) using sterile seawater. An aeration tube consisting of a sterilized rigid plastic tube, a stopper for the top of the flask, and a bacterial air filter will then be placed into the flask. The aeration tube is then attached

to an air pump and the flow rate is adjusted so that the blades are slowly circulating around the beaker but not bubbling onto the side of the beaker above the water.

These cultures can be maintained until the desired blade size is reached. As they grow, it is beneficial to transfer them into larger flasks (i.e. 4 L Erlenmeyer flasks) or aquaria to promote growth (Figure 6.12). While it is possible to use an aquarium at this stage, it is discouraged, because it is impossible to maintain sterile conditions in aquaria. Furthermore, even with the best aeration there are often dead zones in aquaria that allow for the settling out of seaweed onto the bottom. Constant motion of blades ensures optimum uptake of nutrients and more even exposure to high light levels to enable faster growth.

Blades can then be added to large aquaculture tanks if desired and allowed to grow until harvestable size. If tanks need to be maintained at low temperatures, then a chiller can be used although they require an outside pump for circulating water. Tanks can also be wrapped with insulation such as foam board to decrease the rate of heat exchange between the tank and the outside environment and conserve energy. If the seaweed is to be added to an already existing recirculating tank system then this equipment is probably already in place. Blades

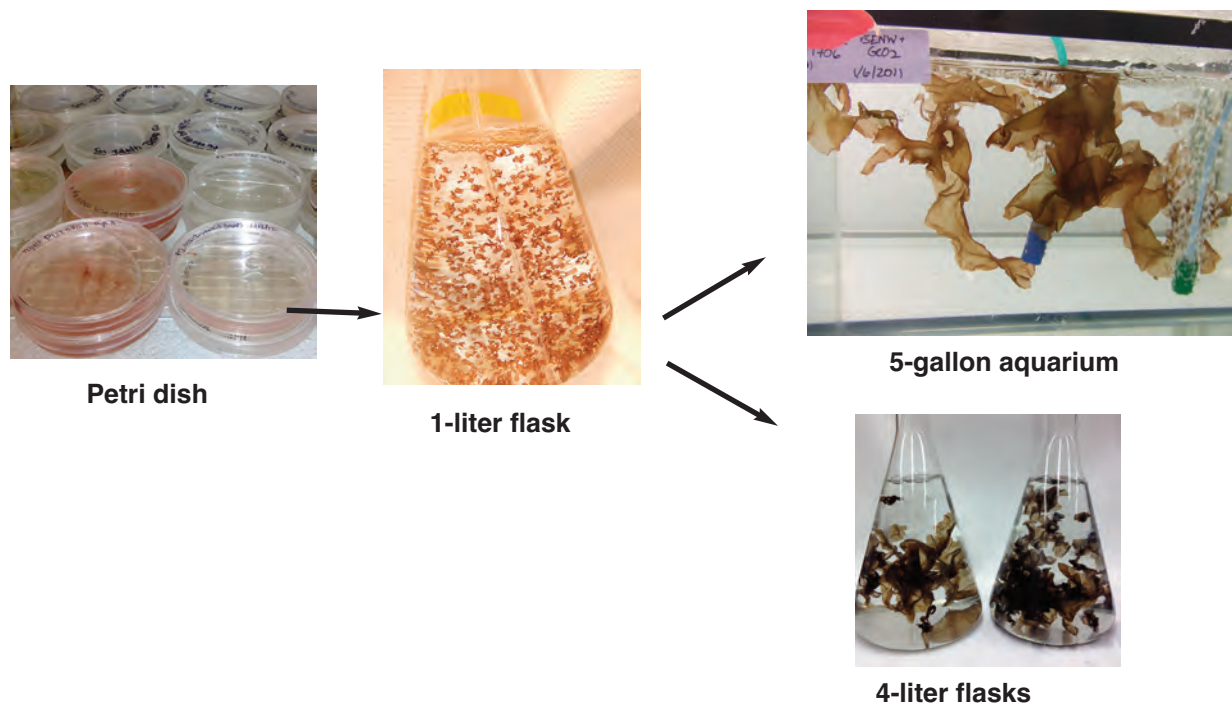

Figure 6.12. Demonstration of the sequential transfer of nori cultures

should be monitored for signs of reproductive development. If blades become reproductive two things should occur: 1) several blades should be selected to undergo spore release to achieve another seed stock generations and 2) blades should be harvested prior to release of spores in the aquaculture tank because they can clog filters. Constant production of seed stocks will need to be maintained.

Tank System Operation

Considerations for Grow-Out in Tank-Based Systems

There are several types of tank-based systems that can be used to grow nori. Typically, tank-based IMTA systems are recirculating (i.e. closed). In these types of systems, there is little if any seawater exchange as the goal is to conserve water through recirculation. Tanks containing seaweeds in recirculating systems will still require temperature regulation, aeration (i.e. plant agitation), and light. The fed crop will supply nutrients for seaweed growth in IMTA systems and little or no addition will be required.

Seaweeds can also be grown in flow-through systems where the water enters at one end and leaves at the other. In these systems, seawater exchange rates must be considered.

Seawater Exchange

When culturing nori in flow-through tank systems, seawater exchange rates must be determined in order to ensure proper removal of waste metabolites and delivery of required nutrients. Flushing rates must equal or exceed the rate at which phytoplankton (microscopic photosynthetic algae) contamination, waste metabolites, and algal debris accumulates in the tanks (Craigie & Shacklock, 1995). Tank systems for growing red seaweeds typically have water exchange rates between 3 and 7 tank volumes per week (Craigie & Shacklock, 1995). Water exchange can also be an important mechanism for temperature control and the addition of certain nutrients such as carbon through the bubbling of CO₂. Systems can be set up to be fully automatic and respond to parameters such as temperature, irradiance, and pH (Bidwell *et al.* 1985).

Blade Agitation

Another important consideration in tank culture is a method of blade agitation. Agitation serves many roles including keeping negatively buoyant blades in suspension, mixing nutrients, improving the rate of nutrient absorption, and allowing blades to periodically absorb sunlight while preventing overexposure (Craigie & Shacklock, 1995). Different modes of agitation include air sparging, water jets, and paddle wheels have been tried but air sparging is the best technique for tank-based culturing. Typically, long stainless steel pipes with holes drilled in them are placed at intervals on the bottom of the tank and aeration is provided using air pumps. The geometry of the tank will influence the placement of the air pipes (Figure 6.13).

The goal is to create a circulation pattern within the tank that does not have any dead zones. The rate of aeration can also be adjusted to achieve this goal.



Figure 6.13. Ten-gallon aquarium with *P. umbilicalis*. Note stainless steel aeration pipe in the back of the aquarium

Pests and Weeds

Nori that is grown in open water net cultivation systems is particularly prone to contamination. In these systems, the nets are often removed from the water for an allotted amount of time every day or every other day in order to allow the nets to dry out. Since most species of nori are intertidal, they are able to easily withstand exposure to the air for hours at a time. However, many of the opportunistic epiphytes on nori nets are not as tolerant.

In tank-based culture, it is virtually impossible to maintain perfectly clean cultures, especially as tank size increases. Using clean, cultivated seed stock to start the cultures will help keep epiphytes at a minimum. Also, maintaining a large stocking density will ensure that epiphytes will effectively be crowded out. The addition of germanium dioxide can be considered to deal with diatom contamination, but considerations for impacts on other animals in the recirculating system should be made before any chemical treatments are given.

Stocking Density

Stocking density is a function of nutrient production and absorption. When integrating seaweeds into recirculating IMTA aquaculture systems, the production of inorganic nutrients by the fed crop needs to be properly coupled with the nutrient removal of the seaweeds (Figure 6.14). Nori, as previously mentioned, is one of the most efficient seaweeds at removing inorganic nitrogen and phosphorous from the water. The production of inorganic wastes by fish will be based on several factors including stocking density of fish and the amount of feed they are given. Efficiency of inorganic nutrient removal by different species and water exchange rate also need to be taken into account (Day, 2008). Day (2008) created predictive models that incorporate these parameters and predict how much nori biomass is required. For example, a fish biomass of 5 kg require 1 kg of *P. umbilicalis* to bring the ammonium-nitrogen level to below 25 μM. At a fish biomass of 40 kg, it is predicted that you would need 6 kg of *P. umbilicalis* and the ammonium-nitrogen levels would be around 35 μM (Day, 2008). Nutrient models such as these should play a large role in the determination of stocking density based on individual systems.

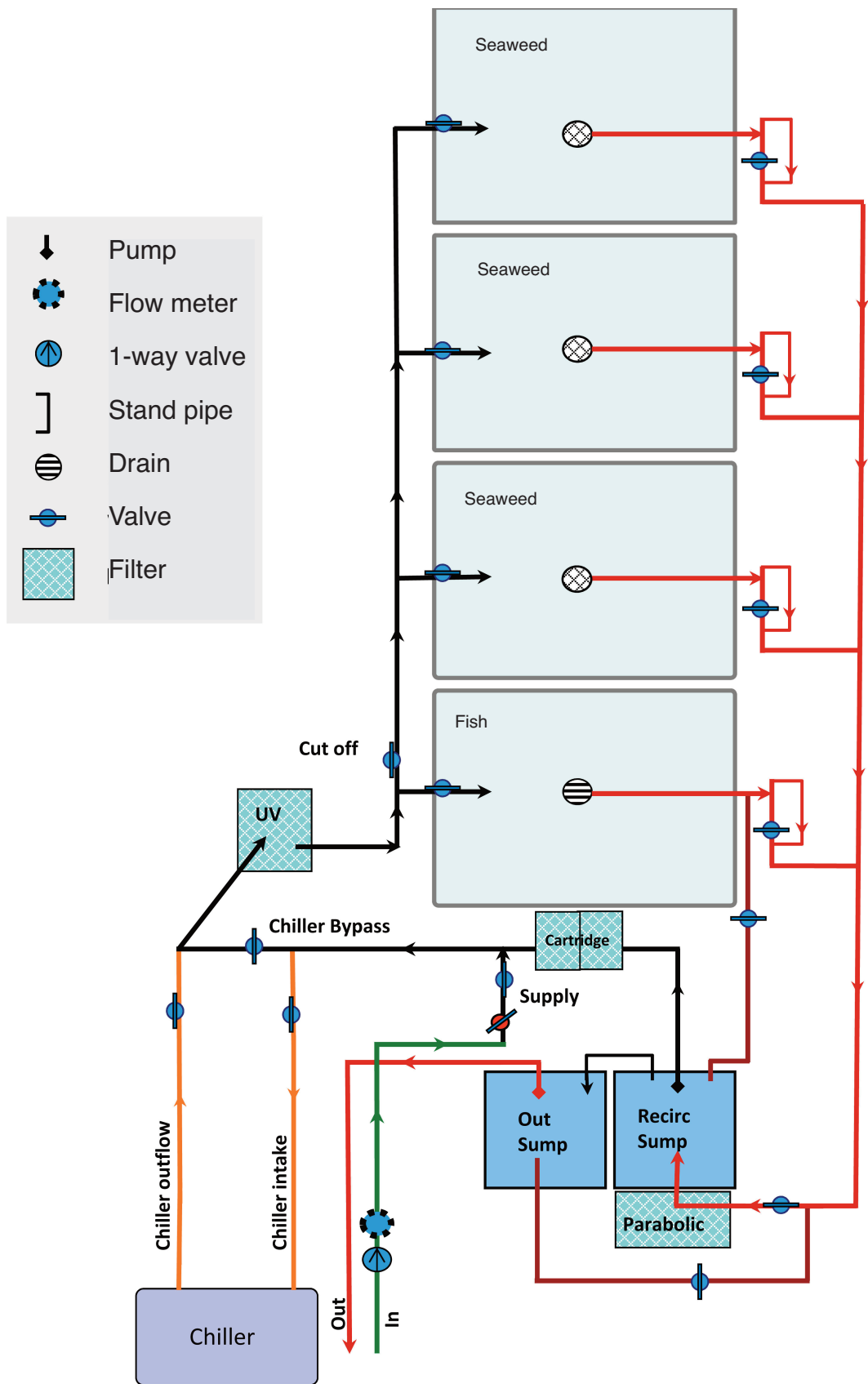

Figure 6.14. Schematic of experimental recirculating integrated multi-trophic aquaculture system containing cod and nori. The tank closest to the filters contained the fish while the three other tanks contained seaweed (Courtesy of Day, 2008).

Nutritional Requirements

The major macronutrients that all seaweeds require for growth are nitrogen, phosphorus, and carbon. Nori also has requirements for elements that are normally present as dissolved salts in seawater including iron, copper, manganese, zinc, cobalt, chlorine, molybdenum, magnesium, calcium, potassium, sulfur, oxygen, and hydrogen. When growing nori with rapid growth rates, several limiting nutrients become obvious.

Carbon is required for photosynthesis and nori has the ability to rapidly absorb carbon from the water. As carbon is absorbed, the pH of the water increases, resulting in a decrease or stop in photosynthesis. Supplying carbon through bubbling helps to maintain optimal pH while supplying additional carbon to the blades (Craigie & Shacklock, 1995). However, bubbling CO₂ directly is inefficient because carbon dissolves slowly in water (Bidwell *et al.* 1985). Bidwell *et al.* (1985) suggests that stirring CO₂ into the water in the seawater inlet pipes allows for more carbon to be dissolved and for better uniform distribution of the carbon to all of the blades.

Nitrogen is a major limiting factor in seaweed cultivation and when nitrogen becomes limiting nori loses its pigmentation and can even bleach. Nitrogen depletion often leads to an increased flow in the products of photosynthesis being turned into carbohydrates and lipids. Furthermore, it is important to remember that the pigmentation of nori is closely linked with the availability of nitrogen. In recirculating systems, nitrogen will be supplied in the form of ammonia (if the fed crop is fish or shrimp), which will then be taken up by the nori and converted into phycobilin pigments and other nitrogenous compounds. In the absence of adequate nitrogen, nori can mobilize phycobilins as nitrogen stores for use in photosynthesis and other metabolic functions, resulting in a loss in pigmentation.

Phosphorus deficiency reduces productivity in nori cultures. The phosphorus needed for the culture is typically achieved through the addition of ammonium phosphate monobasic (NH₄)₂HPO₄ fertilizer for a maximum pulse of 0.1 μM phosphate. A lag period in growth is typical after the addition of phosphorus (Craigie & Shacklock, 1995).

In tank culture it is usually not necessary to add trace metals to the water if a high flow rate is maintained and natural seawater is used. Occasionally, the addition of iron in a chelator form such as EDTA (ethylenediaminetetraacetic acid) has been required for the cultivation of other red seaweeds (*Chondrus*), but has not been reported for nori (Craigie & Shacklock, 1995).

In terms of when to add nutrients to cultures, Bidwell *et al.* (1985) reported that pulse fertilizing at a rate of three times per week gave better production than one weekly addition. They further suggested adding the nutrients during a period when there is no flushing to avoid losing them (i.e. if you flush your system during the day you should add the nutrients during the night and vice versa). Craigie (1990) reported that pulse fertilizing was also an effective strategy for the control of epiphytes. The correct amount of nitrogen and phosphorus are added to the culture by mixing the necessary weights of (NH₄NO₃) and [(NH₄)HPO₄] fertilizers together and adding them to the culture tanks until a 1 mM nitrogen and 1 μM phosphate concentration is achieved. To calculate molar concentrations you will need to molecular weight of the chemical, which should be indicated on the packaging information. The molecular weight is the grams of the compound that you should add to 1 liter of water to achieve a 1 molar (M) concentration (1 millimolar, mM, is 10⁻³ molar and 1 micromolar, μM, is 10⁻⁶ molar). You can then calculate the grams you need to achieve your desired concentration based on the amount of water in your system. The amount of each fertilizer necessary to meet the proper concentrations will vary depending on the size of the tank (Craigie & Shacklock 1995).

Tank Design

All of the above-mentioned variables (seawater exchange, blade agitation, stocking density, and nutritional requirements) need to be taken into consideration when designing tank systems (Figure 6.15). In most circumstances, the tank systems will already be in operation and the integration of seaweed into them will not require building or designing tanks. As you begin to scale up production of nori, one of the most costly expenses will be lighting. For reference, on a typical mid-summer day around noon, the sun is emitting 2000-2500 μmol photons m⁻² s⁻¹. In most laboratory settings, cultures are maintained at less than 300 μmol photons m⁻² s⁻¹. While most nori species reach light saturating photosynthesis between 200-250 μmol photons m⁻² s⁻¹ increasing stocking density will require an increase in light output. Clearly, the most efficient way to light your cultures is to use a greenhouse that allows ambient light. In some circumstances, however, that is not possible. There will be trade-offs between cost and light if you do not have a natural source of light. These decisions will be unique to each individual system and will depend on the stocking density, depth, and volume of the tanks.

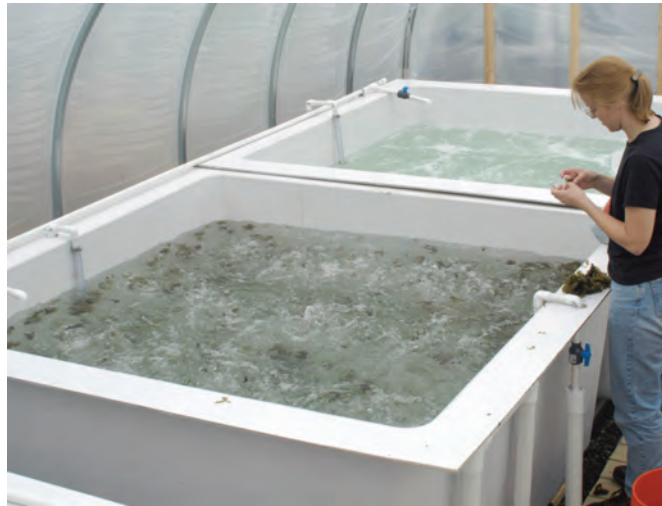

Figure 6.15. Greenhouse containing the experimental recirculating aquaculture system (left) and tank containing nori (right). Courtesy of Jennifer Day..

References & Suggested Readings

- Abreu, M.H., R. Pereira, I. Sousa-Pinto and C. Yarish. 2011. Nitrogen uptake response of *Gracilaria vermiculophylla* (Ohmi) Papenfuss under combined and single addition of nitrate and ammonium. *J. Exp. Mar. Biol. Ecol.* 407 (2): 190-199.
- Andersen, R. 2005. *Phycological Methods: Algal Culturing Techniques*. Academic Press, Elsevier Publ. 578 pp.
- Barrington K., Chopin T. and S. Robinson. 2009. Integrated multi-trophic aquaculture (IMTA) in marine temperate waters. In: Soto D. (ed) 1540 Integrated aquaculture: a global review. *FAO Fisheries and Aquaculture Technical Paper*. No. 529. FAO, Rome, pp 7–46.
- Bartsch, I., Wiencke, C., Bischof, K., Buchholz, C.M., Buck, B.H., Eggert, A., Feuerpfeil, P., Hanelt, D., Jacobsen, S., Karez, R., Karsten, U., Molis, M., Roleda, M.Y., Schubert, H., Schumann, R., Valentin, K., Weinberger, F. and J. Wiese. 2008. The genus *Laminaria sensu lato*: recent insights and developments. *Eur. J. of Phycol.* 43: 1-86.
- Beveridge, M.C.L. 1987. *Cage aquaculture*. Fishing News Books Ltd., Farnham, 352 p.
- Bidwell, R.G.S., J. McLachlan, and N.D.H. Lloyd. 1985. Tank cultivation of Irish moss, *Chondrus crispus* Stackh. *Bot. Mar.* 28: 87-98.
- Bird, N.L., L.C.M. Chen, and J. McLachlan. 1979. Effects of temperature, light and salinity on growth in culture of *Chondrus crispus*, *Furcellaria lumbicalis*, *Gracilaria tikvahiae* (Gigartinales, Rhodophyta) and *Fucus serratus* (Fucales, Phaeophyta). *Bot. Mar.* 22:521-27.
- Bird, C. J., & J.L. McLachlan. 1992. *Seaweed Flora of the Maritimes 1. Rhodophyta—The Red Algae*. Biopress Ltd, Bristol, UK. 176 pp.
- Blouin, N., F. Xiugeng, J. Peng, C. Yarish, and S. Brawley. 2007. Seeding nets with neutral spores of the red alga *Porphyra umbilicalis* (L.) Kutzing for use in integrated multi-trophic aquaculture (IMTA). *Aquaculture* 270: 77-91.
- Bolton J.J., Robertson-Andersson D.M., Troell M. and C. Halling. 2006. Integrated systems incorporate seaweeds in South African abalone aquaculture. *Global Aquaculture Advocate* 8(4): 54–55.
- Braden, K.W., Blanton, J.R., Montgomery, J.L., van Santen, E., Allen, V.G., and M.F. Miller. 2007. Tasco supplementation: effects on carcass characteristics, sensory attributes and retail display shelf-life. *J. Anim. Sci.* 2007: 754-768.
- Brodie, J.A. & L.M. Irvine. 2003. *Seaweeds of the British Isles Volume 1 Rhodophyta Part 3B Bangiophycidae*. The Natural History Museum, London, 167 pp.
- Browdy, C.L., Hulata, G., Liu, Z., Allan, G.L., Sommerville, C., Passos de Andrade, T., Pereira, R., Yarish, C., Shpigel, M., Chopin, T., Robinson, S., Avnimelech, Y. and A. Lovatelli. 2012. Novel and emerging technologies: can they contribute to improving aquaculture sustainability? In R.P. Subasinghe, J.R. Arthur, D.M. Bartley, S.S. De Silva, M. Halwart, N. Hishamunda, C.V. Mohan & P. Sorgeloos, eds. *Farming the Waters for People and Food*. Proceedings of the Global Conference on Aquaculture 2010, Phuket, Thailand. 22–25 September 2010. pp. 149–191. FAO, Rome and NACA, Bangkok.
- Buschmann, A.H., Hernández-González, M.C., Aranda, C., Chopin, T., Neori, A., Halling, C., and M. Troell. 2008a. Mariculture Waste Management. In Sven Erik Jørgensen and Brian D. Fathi (Editor-in-Chief), *Ecological Engineering*. Vol. 3 of *Encyclopedia of Ecology*, 5 vols. pp. 2211-2217 Oxford: Elsevier.
- Buschmann, A.H., Varela, D.A., Hernández-González, M.C., and P. Huovinen. 2008b. Opportunities and challenges for the development of an integrated seaweed-based aquaculture activity in Chile: determining the physiological capabilities of *Macrocystis* and *Gracilaria* as biofilters. *J. Appl. Phycol.* 20 (5):121-128.
- Carmona, R., Kraemer, G.P., and C. Yarish. 2006. Exploring Northeast American and Asian species of *Porphyra* for use in an integrated finfish-algal aquaculture system. *Aquaculture* 252: 54-65.
- Carney, L.T., Waaland, J.R., Klinger, T., and K. Ewing. 2005. Restoration of the bull kelp *Nereocystis luetkeana* in nearshore rocky habitats. *Mar. Ecol. Prog. Ser.* 302: 49–61.
- Chen, L.M., and J. McLachlan. 1972. The life history of *Chondrus crispus* in culture. *Can. J. Bot.* 50: 1055-60.
- Chopin, T., Sharp, G., Belyea, E., Semple, R. and D. Jones. 1999. Open-water aquaculture of the red alga *Chondrus crispus* in Prince Edward Island, Canada. *Hydrobiologia* 398/99: 417-25.

- Chopin, T., Yarish, C., Wilkes, R., Belyea, E. Lu, S. and A.C. Mathieson. 1999. Developing *Porphyra*/salmon integrated aquaculture for bioremediation and diversification of the aquaculture industry. *J. Appl. Phycol.* 11: 463-472
- Chopin, T., Buschmann, A., Halling, C., Troell, M., Kautsky, N., Neori, A., Kraemer, G., Zertuche-Gonzalez, J., Yarish C., and C. Neefus. 2001. Integrating seaweeds into marine aquaculture systems: a key toward sustainability. *J. Phycol.* 37:975-986.
- Chopin, T., Robinson, S.M.C., Troell, M., Neori, A., Buschmann, A.H., and J. Fang. 2008. Multitrophic Integration for Sustainable Marine Aquaculture. In Sven Erik Jørgensen and Brian D. Fathi (Editor-in-Chief), *Ecological Engineering*. Vol. [3] of *Encyclopedia of Ecology*, 5 vols. pp. 2463-2475 Oxford: Elsevier.
- Chopin T. and M. Sawhney. 2009. *Seaweeds and their mariculture*. In: Steele, J.H., Thorpe, S.A., Turekian, K.K. (Eds.), *The Encyclopedia of Ocean Sciences*. Elsevier, Oxford. pp. 4477-4487.
- Conway, E. and K. Cole. 1977. Studies in the *Bangiaceae*: structure and reproduction of the conchocelis of *Porphyra* and *Bangia* in culture (Bangiiales, Rhodophyceae). *Phycologia* 16: 205-216.
- Cordero, P. 2006. Sea vegetables: Man's supplemental food. In: *Seaweed Resources of the World* (Critchley, A. T., Ohno, M., Largo, D.B. editors). Japan International Cooperation Agency, Yokosuka. IMTA): the inorganic extractive component. World Aquaculture Society Meeting Abstracts.
- Craigie J.S. and P.F. Shacklock . 1985. Culture of Irish Moss. in Boghen A.D. (ed) *Coldwater Aquaculture in Atlantic Canada*. Second Edition. The Canadian Institute for research on Regional Development. Moncton. pp. 241-270.
- Craigie, J.S. 1990. Irish moss cultivation: some reflections. In: *Economically Important Marine Plants of the Atlantic Their Biology and Cultivation*. eds. C. Yarish, C.A. Penniman, P. and Van Patten. Connecticut Sea Grant College Program, Groton, pp. 37-52.
- Craigie, J.S., Staples, L.S., and A.F. Archibald. 1999. Rapid bioassay of a red food alga: accelerated growth rates of *Chondrus crispus*. *World Aquac. Mag.* 30: 26-28.
- Craigie, J. 2011. Seaweed extract stimuli in plant science and agriculture. *J. Appl. Phycol.* 23:371-393.
- Cruz-Uribe O., Cheney, D.P. and G.L. Rorrer. 2007. Comparison of TNT removal from seawater by three marine macroalgae. *Chemosphere* 67: 1469-1476.
- Davis, T.A., Volesky, B. and A. Mucci. 2003. A review of the biochemistry of heavy metal biosorption by brown algae. *Water Research* 37: 4311-4330.
- Day, J. P. 2008. The development of a modular integrated recirculating aquaculture system using *Porphyra* (nori) for the bioremediation of marine finfish effluent. Dissertation University of New Hampshire.
- Drew, K.M. 1949. Conchocelis-phase in the life history of *Porphyra umbicalis* (L.) Kütz. *Nature* 164: 748-749.
- Egan, B. and C. Yarish. 1988. The distribution of the genus *Laminaria* (Phaeophyta) at its southern limit in the western Atlantic Ocean. *Bot. Mar.* 31: 155-161.
- Egan, B. and C. Yarish. 1990. Productivity and life history of *Laminaria longicuris* de la Pyl. at its southern limit in the Western Atlantic Ocean. *Mar. Ecol. Prog. Ser.* 76: 263-273.
- Enright, C.T., and J.S. Craigie. 1981. Effects of temperature and irradiance on growth and respiration of *Chondrus crispus* Stackh. In: *Proceedings of the Tenth International Seaweed Symposium*. ed. E.T. Levring, Walter de Gruyter & Co., Berlin, pp. 271-76.
- FAO, 2002, 2003, 2004, 2005, 2006, 2007, 2009, 2010, 2012. SOFIA (The State of the World Fisheries & Aquaculture). FAO Fisheries Department, Rome, Italy. URL: http://www.fao.org/sof/sofia/index_en.htm
- FAO Fisheries and Aquaculture Department. 1996. Report on a regional study and workshop on the taxonomy, ecology and processing of economically important red seaweeds. Project Report, Bangkok, Thailand. URL: <http://www.fao.org/docrep/field/009/ag152e/AG152E14.htm>
- FAO Fisheries and Aquaculture Department. 2003. A guide to the seaweed industry. Fisheries Technical Paper No. 441, FAO, Rome, Italy. URL: <http://www.fao.org/docrep/006/y4765e/y4765e00.htm>
- FAO Fisheries and Aquaculture Department. 2005. *Porphyra* spp. Cultured Aquatic Species Information Programme. Rome, Italy. URL: http://www.fao.org/fishery/culturedspecies/Porphyra_spp/en - tcNA002B

- Flowers, A.B. and K. Bird. 1984. Marine biomass: A long-term methane supply option. *Hydrobiologia* 116-117: 272-275.
- Fowler-Walker, M.J., Wernberg, T. and S.D. Connell. 2006. Differences in kelp morphology between wave sheltered and exposed localities: morphologically plastic or fixed traits? *Mar. Biol.* 148: 755–767.
- Francis, T.L., Maneveldt, G.W. and J. Venter. 2008. Determining the most appropriate feeding regime for the South African abalone *Haliotis midae* Linnaeus grown on kelp. *J. Appl. Phycol.* 20 (5): 147-152.
- Friedlander, M., Krom, M.D., and A. Benamotz. 1991. The effect of light and ammonium on growth, epiphytes and chemical-constituents of *Gracilaria conferta* in outdoor cultures. *Bot. Mar.* 34:161-166
- Gao, K. and K.R. McKinley. 1994. Use of macroalgae for marine biomass production and CO₂ remediation: a review. *J. Appl. Phycol* 6:45-60.
- Gerard, V.A. and K.H. Mann. 1979. Growth and production of *Laminaria longicuris* (Phaeophyta) populations exposed to different intensities of water movement. *J. Phycol.* 15:33–41.
- Guerin, J.M., and K.T. Bird. 1987. Effects of aeration period on the productivity and agar quality of *Gracilaria* sp. *Aquaculture* 64(2):105-110.
- Hanisak, M.D., 1987. Cultivation of *Gracilaria* and other macroalgae in Florida for energy production. In K.T. Bird & P. Benson (eds), *Seaweed cultivation for renewable resources*. Elsevier, Amsterdam, pp 191-218 .
- Harrison, P. and J. Berges. 2005. Marine Culture Media. In: *Algal Culturing Techniques*. ed. R. Anderson. Phycological Society of America, Elsevier Academic Press, NY. pp 21-33.
- He, P. and C. Yarish. 2006. The developmental regulation of mass cultures of free-living conchocelis for commercial net seeding of *Porphyra leucosticta* from Northeast America. *Aquaculture* 257: 373-381.
- Holdt, S.L. and S. Kraan. 2011. Bioactive compounds in seaweed: functional food applications and legislation. *J. Appl. Phycol.* 23:543-597.
- Horn, S.J, Aasen, I.M. and K. Østgaard. 2000. Ethanol production from seaweed extract. *J. Ind. Microbiol. Biot.* 25: 249-254.
- Israel, A. 2010. A fast growing and edible red marine macroalgae In: *Red Algae in the Genomic Age*. eds. J. Seckbach and D.J. Chapman. Springer, pp. 63-75.
- Jones, W.E. 1956. Effect of spore coalescence on the early development of *Gracilaria verrucosa* (Hudson) Papenfuss. *Nature* 178: 426-427.
- Kautsky, N., Troell, M. and C. Folke. 1996a. Ecological engineering for increased production and environmental improvement in open sea aquaculture. In: *Ecological Engineering for Wastewater Treatment*. eds. C. Etnier and B. Guterstam. CRC Press.
- Kawachi, M., and M. Noel. 2005. Sterilization and sterile technique. In: *Algal Culturing Techniques*. Ed. R. Anderson. Phycological Society of America, Elsevier Academic Press, NY. pp 65-81.
- Kawai, H., Motomura, T. and K. Okuda. 2005. Isolation and purification techniques for macroalgae. In: *Algal Culturing Techniques*. ed. R. Anderson. Phycological Society of America, Elsevier Academic Press, NY. pp. 133-144.
- Kim J.K., Kraemer, G.P., Curtis, J., and C. Yarish. 2012. Seaweed aquaculture for bioextraction of nutrients from LIS and Bronx River Estuary. *J. Shellfish Res.* 31: 219.
- Klein, A.S., Mathieson, A.C., Neefus, C.D., Clain, D.F., Taylor, H.A., Teasdale, B.W., West, A.L., Hehre, E.J., Brodie, J., Yarish, C., and A.L. Wallace. 2003. Identification of north-western Atlantic *Porphyra* (Bangiaceae, Bangiales) based on sequence variation in nuclear SSU and plastid *rbcl* genes. *Phycologia* 42 (2): 109-122.
- Kornmann, P. and P.-H. Sahling. 1991. The *Porphyra* species of Helgoland (Bangiales, Rhodophyta). Helgoländ. *Meeresun.* 45: 1-38.
- Kraan, S. 2013. Mass-cultivation of carbohydrate rich macroalgae, a possible solution for sustainable biofuel production. *Mitigat. Adapt. Strat. Global Change* 18: 27-46.
- Kraemer, G.P. & C. Yarish. 1999. Preliminary comparison of the mariculture potential of *Porphyra purpurea* and *Porphyra umbilicalis*. *J. Appl. Phycol.* 11: 473-477.

- Lewin, J. 1966. Silicon metabolism in diatoms. V. Germanium dioxide, a specific inhibitor of diatom growth. *Phycologia* 6:1-12.
- Lu, S., and C. Yarish. 2011. Interaction of photoperiod and temperature in the development of conchocelis of *Porphyra purpurea* (Rhodophyta: Bangiales). *J. Appl. Phycol.* 23: 89-96.
- Lüning, K., and M.J. Dring. 1972. Reproduction induced by blue light in female gametophytes of *Laminaria saccharina*. *Planta* 104: 252–256.
- Lüning, K. 1980. Critical levels of light and temperature regulating the gametogenesis of three *Laminaria* species (Phaeophyceae). *J. Phycol.* 16: 1-15.
- Lüning, K. 1990. *Seaweeds - Their Environment, Biogeography, and Ecophysiology*, In: Yarish, C. and H. Kirkman (editors) Edited Translation of the German language edition Meeresbotanik: Verbreitung, Okophysologie und Nützung der marinen Makroalgen by Klaus Lüning. John Wiley and Sons, Inc. New York, 527 pp.
- Madlener, J.C. 1977. *The sea vegetable book*. Clarkson N. Potter Inc. / Publishers. New York. 288 pp.
- Mann, K.H. 1973. *Seaweeds: their productivity and strategy for growth*. Science 182:975-981.
- Mathieson, A.C., and J.P. Prince. 1973. Ecology of *Chondrus crispus* Stackhouse. In: *Chondrus crispus*. eds. M.J. Harvey, & J. McLachlan, J. Nova Scotia Institute of Science, Halifax, pp. 53-79.
- Matos, J., Costa, S., Rodrigues, A., Pereira, R., and I. Sousa Pinto. 2006. Experimental integrated aquaculture of fish and red seaweeds in Northern Portugal. *Aquaculture* 252: 31-42.
- Matsui, T., Amano, T., Koike, Y., Saiganji, A. and H. Saito. 2006. *Methane fermentation of seaweed biomass*. American Institute of Chemical Engineers Annual Meeting, San Francisco, CA, Omnipress.
- McHugh, D.J. 2003. A guide to the seaweed industry. FAO Fisheries Technical Paper. No. 441. Rome, FAO. 105 pp.
- Merrill, J.E., and D.M. Gillingham. 1991. *Bull kelp cultivation handbook*. Publication No. NCRI-T-91-011. National Coastal Research and Development Institute, Portland, OR.
- Msuya, F.E. and A. Neori. 2002. *Ulva reticulata* and *Gracilaria crassa*: macroalgae that can biofilter effluents from tidal fishponds in Tanzania. *Western Indian Ocean J. Mar. Sci.* 1: 117–126.
- Msuya, F.E. and A. Neori. 2010. The performance and chemical composition of spray-irrigated seaweed *Ulva lactuca* as a crop and as a biofilter of fishpond effluents. *J. Phycol.* 46: 813–817.
- Mugg J., Serrano, A., Liberti, A., and M.A. Rice. 2000. Aquaculture effluent: a guide for water quality regulators and aquaculturalists. Northeast Regional Aquaculture Center. Publication No. 00-003.
- Muñoz, A.A. and B. Santelices. 1994. Quantification of the effects of sporeling coalescence on the early development of *Gracilaria chilensis* (Rhodophyta). *J. Phycol.* 30: 387-392.
- Neori, A. 1996. The type of N-supply (ammonia or nitrate) determines the performance of seaweed biofilters integrated with intensive fish culture. *Israeli J. Aquacul. Bamidgeh* 48: 19-27.
- Neori, A., Krom, M.D., Ellner, S.P., Boyd, C.E., Popper, D., Rabinovitch, R., Davison, P.J., Dvir, O., Zuber, D., Ucko, M., Angel, D, and H. Gordin. 1996. Seaweed biofilters as regulators of water quality in integrated fish-seaweed culture units. *Aquaculture* 141: 183-199.
- Neori, A., and M. Shpigel. 1999. Using algae to treat effluents and feed invertebrates in sustainable integrated aquaculture. *World Aquaculture* 30(2):46-49.
- Neori, A., Shpigel, M., and D.Ben-Ezra. 2000. A sustainable integrated system for culture of fish, seaweed and abalone. *Aquaculture* 186: 279-291.
- Neori, A., and M. Shpigel. 2003. *Algae: a key for sustainable integrated mariculture*. Proceedings of the Aquaculture Europe 2003 –Beyond Monoculture, August 8–12, 2003. Trondheim, Norway, pp. 52–57.
- Neori, A., Chopin, T., Troell, M., Buschmann, A.H., Kraemer, G., Halling, C., Shpigel, M., and C. Yarish. 2004. Integrated aquaculture: rationale, evolution and state of the art emphasizing seaweed biofiltration in modern aquaculture. *Aquaculture* 231: 361-391.
- Neori, A., Troell, M., Chopin, T., Yarish, C., Critchley, A., and A.H. Buschmann. 2007. The need for ecological balance in “blue revolution” aquaculture. *Environment* 49(3): 36-42.

- Neori, A. 2008. Essential role of seaweed cultivation in integrated multi-trophic aquaculture farms for global expansion of mariculture: an analysis. *J. Appl. Phycol.* 20(5): 117-120.
- New, M.B. 1999. Global aquaculture: current trends and challenges for the 21st century. *World Aquaculture* 30: 63-79.
- Nisizawa, K. 1987. Preparation and marketing of seaweeds as foods. In *Production and Utilisation of Products from Commercial Seaweed*. Ed. D.McHugh. FAO Fisheries Technical Paper 288.
- Nisizawa, K. 2006. Seaweeds kaiso - bountiful harvest from the sea. In: *Seaweed Resources of the World*. eds. A.T. Critchley, M. Ohno, and D.B. Largo. ETI Information Services Ltd.; 2006. DVD-ROM; ISBN: 90-75000-80-4.
- Norziah, M.H. and C.Y. Ching. 2000. Nutritional composition of edible seaweed *Gracilaria changgi*. *Food Chem.* 68: 69-76.
- North, W.J. 1971. Mass cultured *Macrocystis* as a means of increasing kelp stands in nature. In: *Proc Intl Seaweed Symp 7*. Science Press, Sapporo, pp. 349-399.
- North, W.J. 1976. Aquacultural techniques for creating and restoring beds of giant kelp, *Macrocystis* spp. *J. Fish. Res. Board. Can.* 33: 1015-1023.
- Ott, F.D. 1965. Synthetic media and techniques for the xenic cultivation of marine algae and flagellata. *Virg. J. Sci.* 16:205-218.
- Pereira, R. and C. Yarish. 2010. The role of *Porphyra* in sustainable culture systems: physiology and applications. In: *Role of Seaweeds in a Globally Changing Environment*. eds. A. Israel and R. Einav. Springer Publishers. pp. 339-354.
- Pereira, R., Yarish, C., and A. Critchley. 2012. Seaweed aquaculture for human foods in land-based and IMTA systems. In: *Sustainability Science in Aquaculture, Ocean Farming and Sustainable Aquaculture Science and Technology, Encyclopedia of Sustainability Science and Technology*. eds. B.A. Costa-Pierce and G.G. Page, Springer Science, N.Y.
- Prince, J.S., and J.M. Kingsbury. 1976. The ecology of *Chondrus crispus* at Plymouth, Massachusetts: effects of elevated temperature on growth and survival. *Biological Bulletin* 145: 580-88.
- Provasoli, L. 1968. Media and prospects for the cultivation of marine algae. In: *Cultures and Collections of Algae*. Eds. A. Watanabe and A. Hattori. Proc. U.S. - Japan Conf. Hakone, September 1966. *Jap. Soc. Plant Physiol.*, pp. 63-75.
- Robertson-Andersson, D.V., Potgieter, M., Hansen, J. Bolton, J.J., Troell, M., Anderson, R.J., Halling, C. and T. Probyn. 2008. Integrated seaweed cultivation on an abalone farm in South Africa. *J. Appl. Phycol.* 20 (5): 129-146.
- Rose, J.M., Tedesco, M., Wikfors, G.H., and C. Yarish. 2010. International workshop on bioextractive technologies for nutrient remediation summary report. US Dept. Commerce, Northeast Fish Sci Center Ref Doc. 10-19; 12 pp. Available from: National Marine Fisheries Service, 166 Water Street, Woods Hole, MA 02543-1026.
- Sahoo, D. and C. Yarish. 2005. Mariculture of seaweeds. In: *Phycological Methods: Algal Culturing Techniques*. ed. R. Andersen. Elsevier Academic Press, Burlington, pp. 219-237.
- Saker, K.E., Fike, J.H., Veit, H. and D.L. Ward. 2004. Brown seaweed- (Tasco) treated conserved forage enhances antioxidant status and immune function in heat-stressed weather lambs. *J. Animal Physiol. Anim. Nutr.* 88: 122-130.
- Sampath-Wiley, P., Neefus, C.D., and L.S. Jahnke. 2008. Seasonal effects of sun exposure and emersion on intertidal seaweed physiology: fluctuations in antioxidant contents, photosynthetic pigments and photosynthetic efficiency in the red alga *Porphyra umbilicalis* Kützinger (Rhodophyta, Bangiales). *J. Exp. Mar. Biol. Ecol.* 361: 83-91.
- Sanchez-Machaado, D.I., Lopez-Cervantes, J., Lopez-Hernaned, J. and P. Paseiro-Losado. 2004. Fatty acids, total lipids, protein and ash contents of processed edible seaweeds. *J. Food Chem.* 85: 439-444.
- Sidirelli-Wolff, M. 1992. The influence of temperature, irradiance and photoperiod on the reproductive life history of *Porphyra leucosticta* (Bangiales, Rhodophyta) in laboratory culture. *Bot. Mar.* 35: 251-257.
- Simpson, F.J., and P.F. Shacklock. 1979. The cultivation of *Chondrus crispus*. Effect of temperature on growth and carrageenan production. *Bot. Mar.* 22: 295-98.
- Smit, A.J. 2004. Medicinal and pharmaceutical uses of seaweed natural products. a review. *J. Appl. Phycol.* 16: 245-262.
- Smit, A., Robertson, B.L., and D.,R. du Preez. 1996. Influence of ammonium-N pulse concentrations and frequency, tank condition and nitrogen starvation on growth rate and biochemical composition of *Gracilaria gracilis*. *J. Appl. Phycol.* 8: 473-481.

- Steneck, R.S., Graham, M.H., Bourque, B.J., Corbett, D., Erlandson, J.M., Estes, J.A., and M.J. Tegner. 2002. Kelp forest ecosystems: biodiversity, stability, resilience and future. *Environ. Conserv.* 29: 436-459.
- Sutherland, J.E., Lindstrom, S.C., Nelson, W.A., Brodie, J., Lynch, M.D.L., Hwang, M.S., Choi, H.-G., Miyata, M., Kikuchi, N., Oliviera, M.C., Farr, T., Neefus, C., Mols-Mortensen, A., Milstein, D., and K.M. Muller. 2011. A new look at an ancient order: generic revision of the Bangiales (Rhodophyta). *J. Phycol.* 47: 1131-1151.
- Teas, J. 2006. Dietary brown seaweeds and human health effects. In: *Seaweed Resources of the World*. eds. A.T. Critchley, M. Ohno, and D.B. Largo. Japan International Cooperation Agency, Yokosuka.
- Troell, M., Hailing, C., Neori, A., Buschmann, A.H., Chopin, T., Yarish, C., and N. Kautsky. 2003. Integrated mariculture: asking the right questions. *Aquaculture* 226: 69-90.
- Troell, M., Robertson-Andersson, D., Anderson, R.J., Bolton, J.J., Maneveldt, G., Hailing, C., and T. Probyn. 2006. Abalone farming in South Africa: An overview with perspectives on kelp resources, abalone feed, potential for on-farm seaweed production and socio-economic importance. *Aquaculture* 257: 266-281.
- Turner, J., Dritz, S.S., Higgins, J.J. and J.E. Minton. 2002. Effects of *Ascophyllum nodosum* extract on growth performance and immune function of young pigs challenged with *Salmonella typhimurium*. *J. Anal Sci.* 80: 1947-1953.
- Tveter, E., and A.C. Mathieson. 1976. Sporeling coalescence in *Chondrus crispus* (Rhodophyceae). *J. Phycol.* 12: 110-118.
- Van Patten, P. and C. Yarish. 1993. Allocation of blade surface to reproduction in *Laminaria longicruris* of Long Island Sound. *Hydrobiologia* 260/261: 173-181.
- Walker, A.B., Fournier, H.R., Neefus, C.D., Nardi, G.C., and D.L. Berlinsky. 2009. Partial replacement of fishmeal with Laver (*Porphyra* spp.) in diets of Atlantic cod (*Gadus morhua*). *N. Am. J. Aquacult.* 71: 39-45.
- West, J.A. 2005. *Long term macroalgal culture maintenance*. In: *Phycological Methods: Algal Culturing Techniques*. ed. R. Andersen. Academic Press, Elsevier Publ. pp. 157-164.
- Westermeier, R., Patin, D., Ines Piel, M., Maier, I., and D.G. Mueller. 2006. A new approach to kelp mariculture in Chile: production of free-floating sporophyte seedlings from gametophyte cultures of *Lessonia trabeculata* and *Macrocystis pyrifera*. *Aquac. Res.* 37: 164-171.
- Yang, Y. and C. Yarish 2011. *Gracilaria* cultivation can provide bioremediation in Chinese mariculture mussel culture. *Global Aquaculture Advocate* 14 (1): 50-51.
- Yarish, C. 2011. "Development of Seaweed Culture System Technologies to Support Integrated Multi-trophic Aquaculture and Sea Vegetable Aquaculture in New England" Year 1 Progress Report (Feb. 1, 2010 – Jan. 31, 2011). Connecticut Sea Grant.
- Yarish, C. and R. Pereira. 2008. Mass production of marine macroalgae. In: *Ecological Engineering Vol. 3 of Encyclopedia of Ecology*. eds. S.E. Jørgensen and B.D. Fath, Vol. Oxford: Elsevier. pp. 2236-2247.
- Yarish, C., Penniman, C.A. and M. Van Patten (eds). 1990. *Economically important marine plants of the atlantic: their biology and cultivation*. Conn. Sea Grant College Program, Groton, CT, 158 pp.
- Yarish, C., Wilkes, R., Chopin, T., Fei, X.G., Mathieson, A.C., Klein, A.S., Neefus, C.D., Mitman, G.C., and I Levine. 1998. Domestication of indigenous *Porphyra* (nori) species for commercial cultivation in Northeast America. *World Aquaculture* 29: 26-29.
- Yarish, C., Brinkhuis, B.H., Egan, B., and Z. Garcia-Ezquivel. 1990. Morphological and physiological bases for *Laminaria* selection protocols in Long Island Sound aquaculture. In: *Economically Important Plants of the Atlantic: Their Biology and Cultivation*. eds. C. Yarish, C.A. Penniman, and P. Van Patten. Conn. Sea Grant Program, Groton, CT.
- Yokoyama, Jonouchi, S., and K. and Imou. 2007. Energy production from marine biomass: fuel cell power generation driven by methane produced from seaweed. *Proc. World Academy of Science, Engineering and Technology* 22: 320-323.
- Yosida, T., Notoya, M., Kikuchi, N., and M. Miyata. 1997. Catalogue of species of *Porphyra* in the world, with special reference to the type locality and bibliography. *Nat. Hist. Res.* 3: 5-18.
- Zertuche-González, J.A., García-Lepe, G., Pacheco-Ruiz, I., Gendrop, V., and J.M. Guzmán. 2001. Open water *Chondrus crispus* Stackhouse cultivation. *J. Appl. Phycol.* 13: 249-253.

Appendix

Lighting

- Light resources: bulbs, information, and distributors
- GE Lighting: <http://www.gelighting.com>
- Philips: <http://www.usa.lighting.philips.com>
- Sylvania: <http://www.sylvania.com>
- Guth Philips: <http://www.guthlighting.com>

Handheld Quantum Light Meters

- Apogee Instruments <http://www.apogeeinstruments.com>
- LI-COR Environmental <http://www.licor.com>

Light measurements

- $\mu E = \mu\text{mol photons m}^{-2} \text{ s}^{-1} = (\text{lux})(0.013)$
- Light measurements conversions: http://www.egc.com/useful_info_lighting.php

Supplies

Artificial Sea Water

- Instant Ocean: <http://www.instantocean.com>
- Tropic Marin Sea Salt <http://www.tropic-marin.com>
- Ultramarine Synthetica: <http://www.waterlife.co.uk/seaquariums/ultramarine.htm>
- Sigma-Aldrich Dry Sea Salt Mixture: <http://www.sigmaaldrich.com>

Pre-mixed Enrichment Stocks

- National Center for Marine Alga and Microbiota NCMA (formerly CCMP): <https://ncma.bigelow.org/>
- Culture Collection of Algae and Protozoa (CCAP): <http://www.ccap.ac.uk>
- Sigma-Aldrich f/2 media: <http://www.sigmaaldrich.com>
- f/2-AlgaBoost, ES enrichment stocks: <http://www.algaboost.com>

Aquarium Equipment & Supplies

Tanks, pumps, aeration, tubing, filters, lighting, etc

- Deep Blue Professional: <http://www.deepblueprofessional.com>
- Pentair Aquatic Eco-Systems Inc.: <http://www.PentairAES.com>
- Lifeguard Aquatics: <http://www.lifegardaquatics.com>
- Frigid Units, Inc.: <http://www.frigidunits.com>
- Emperor Aquatics, Inc.: <http://www.emperoraquatics.com>
- Aqualogic: <http://www.aqualogicinc.com>
- Polytank, Inc.: <http://www.polytankco.com>
- Ironfish Aquaculture Directory: <http://www.ironfish.org>
- Percival Scientific: <http://www.percival-scientific.com>
- Omega Engineering Inc.: <http://www.omega.com>
- Hydroponic and Greenhouse Suppliers: e.g., <http://www.sunlightsupply.com>, <http://www.hydrofarm.com>, etc.

Laboratory

Agar Media for Preparation of Agar Plates

- To prepare sterile agar plates, use new disposable plastic Petri dishes or sterilized glass Petri dishes.
- An agar solution is prepared by adding 1.5% agar powder to a 50:50 sterilized seawater/fresh water solution in a flask.
- The media should be microwaved or heated on a stir plate to both fully dissolve the agar powder and to sterilize the solution (about 5 minutes). Cover the opening of the flask with tinfoil upon removal.
- Prepare a clean working space free of any air currents to pour hot agar into plates. An open flame in the working space is used to sterilize the neck of the flask by passing it through the flame before pouring.
- While pouring the agar solution, open the Petri dishes as little as possible, holding the cover at an angle, and keep the lid over the dish. Cover the poured dish. Place agar plates on an undisturbed surface to cool and set. Agar medium will set into a stiff gel at room temperature.
- Stack cooled and hardened agar plates upside down in the refrigerator. Do not freeze. Plates are stacked upside down to prevent condensation from dripping down onto the agar surface.

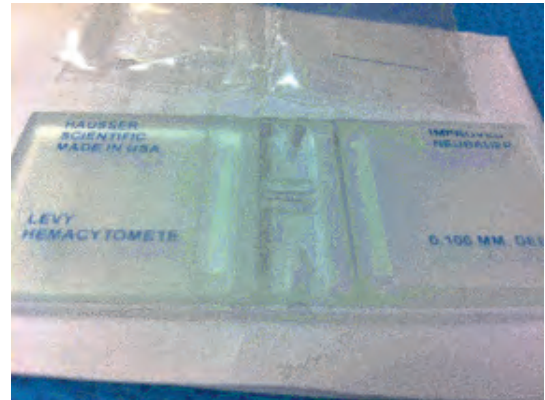

Haemocytometer and coverslips

Haemocytometer counts for cell density

A bright line haemocytometer is a specially etched glass slide made for taking blood cell counts, but is also useful for spore density calculations because it allows for an estimation of number of cells per milliliter of spore solution. The center of the haemocytometer slide contains two loading wells, each leading to a number of etched blocks on top of the slide which are apparent under the microscope. A haemocytometer comes with a special cover slip, and this should be placed over the center of the etched glass. There are two small wells on both sides of the glass slide, under the cover slip. These are loaded by placing a well-mixed drop of the sample solution in each well with a fine tipped pipette. The drop containing the spores will be pulled over the series of blocks, each with a different grid pattern. The middle block is divided up into 25 gridded squares, representing 10^{-4} ml. This is the block that should be counted. The haemocytometer should be viewed at 100x or 200x, and one square at a time should be counted. It may be easier to view the etched blocks under the microscope by turning down the light and closing the aperture of the microscope to increase contrast. The eyes should be methodically moved from the left to the right, and a consistent way of counting the cells on lines should be established. Cells on dividing lines are only counted in each square from the top (or bottom) and the left (or right). Consistency is very important for getting cell counts. A handheld clicker can be used if the density is very high, or the solution can be diluted by adding more seawater to count a more manageable sample.

Density Calculation

Count the number of spores found in the 25 blocks that make up the middle block of the haemocytometer. This number represents the amount of cells in 10^{-4} ml, so to find the density of spores per ml, just add 4 zeros to your count.

Example: Count = 40 spores

Just add 4 zeros to your count = 400,000 spores / mL

Now to find the total amount of spores available, multiply this by the total amount of spore solution that you have: Example: 100ml * 400,000 spores = 40,000,000 spores / 100 mL

To determine the amount of spore solution to add to your spools for inoculation, determine the total amount of seawater being used for the inoculation:

Example: 6 Liters = 6,000 mL

Spools should be inoculated at 2,000-5,000 spores/mL. To find the total amount of spores needed for your inoculation, multiply your desired density by the total amount of seawater being used.

Example: 2,000 spores/mL * 6,000 mL = 12,000,000 spores total

Now you can divide the total amount of spores by the number of spores per mL in order to determine how many mL of spore solution you should add to inoculate your spools.

Example: 12,000,000 spores / 400,000 spores mL⁻¹ = 30 mL spore solution

Germanium Dioxide

Diatoms are a common type of contamination in seaweed cultures, but can be eliminated with addition of a saturated solution of germanium dioxide to culture media. A saturated stock solution can be prepared by dissolving 250mg of GeO₂ per 1 Liter of deionized water. This stock solution is then added to culture media at a concentration of 2mL/L seawater. Stock solutions should be stored in a refrigerator and properly labeled. Brown algae are also sensitive to high concentrations of GeO₂, so this concentration should not be exceeded when culturing kelp. One to two weeks of treatment is usually sufficient to eliminate diatoms in a culture.

Micropipette Preparation

Micromanipulation by micropipette allows for the selection and isolation of microscopic spores under a microscope. Micropipettes can be prepared in the laboratory using disposable glass Pasteur pipettes.

Holding the top of the pipette in one hand, and the small-bore end with a pair of steel forceps, hold the end of the pipette over an open flame to soften the glass until malleable. Take the pipette out of the flame and pull the ends apart, stretching the glass to form a very small bore. Snap the end off, and carefully place aside. Several of these micropipettes can be made up beforehand for isolation work under the microscope.

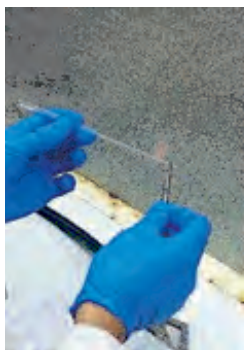

1) Hold glass pipette over flame until soft.

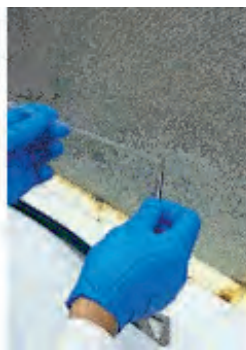

2) Pull ends apart to stretch glass.



3) Snap off end.

Nutrient Media

PROVASOLI ENRICHED SEAWATER MEDIA (PES)			
To the base solution (I), add the following amounts of prepared solutions II, III, & IV			
Enrichment Stock Solution	Quantity (ml) 1000 (final)	X2 (ml) 2000 (final)	X3 (ml) 3000 (final)
Solution I: Base Solution	599 (final)	1198 (final)	1797 (final)
Solution II: Fe (as EDTA complex; 1:1molar)	200	400	600
Solution III: P II metals	200	400	600
Solution IV: Vitamins Vitamin B ₁₂ , Biotin	1	2	3
*Adjust pH of final solution to 7.8 using HCl			
Solutions I, II, III & IV			
Ingredients			
<u>Solution I: Base Solution</u>	Quantity	Quantity (X2)	Quantity (X3)
Deionized water	599	1198	1797
Tris Buffer	4 g	8 g	12 g
NaNO ₃	2.8 g	5.6 g	8.4 g
Na ₂ glycerophosphate	0.4 g	0.8 g	1.2 g
Thiamine-HCl (Vit. B ₁)	0.004 g	0.008 g	0.012 g
<u>Solution II: Fe (as EDTA complex; 1:1 molar)</u>	Quantity	Quantity (X2)	Quantity (X3)
Deionized water	1L (total)	2L (total)	3L (total)
Fe (NH ₄) ₂ (SO ₄) ₂ · 6H ₂ O	0.700 g	1.4 g	2.1 g
Na ₂ EDTA	0.600 g	1.2 g	1.8 g
<u>Solution III: P II metals</u>	Quantity	Quantity (X2)	Quantity (X3)
Deionized water	1L (total)	2L (total)	3L (total)
Na ₂ EDTA (Disodium ethylenediamine tetraacetate)	1 g	2 g	3 g
H ₃ BO ₃ (Boric Acid)	1.140 g	2.28 g	3.42 g
FeCl ₃ · 6H ₂ O (Ferric Chloride)	0.049 g	0.098 g	0.147 g
MnSO ₄ · H ₂ O (Manganese sulfate monohydrate)	0.130 g	0.26 g	0.39 g
CoSO ₄ · 7H ₂ O (Cobaltous sulfate heptahydrate)	0.005 g	0.01 g	0.015 g
ZnSO ₄ · 7H ₂ O (Zinc sulfate, 7-hydrate)	0.022 g	0.044 g	0.066 g
<u>Solution IV: Vitamins</u>	Quantity		
Deionized water	25 mL (total)		
Vitamin B ₁₂	0.002 g		
Biotin	0.001 g		

Notes on PES preparation

- Solutions II, III, & IV should be made up as separate solutions to be added to base solution I. Prepare the base solution by dissolving ingredients in about half of the total volume of water, and then add solutions II, III, and VI before adding the remaining water to bring the final volume up to 1, 2 or 3 liters.
- If enriching natural seawater, boric acid can be left out of solution III.
- Prepare solutions separately using clean sterilized volumetric flasks, clean pipettes, and digital balance. Mix with magnetic stirring bars.
- pH should be adjusted with HCl after media is prepared.
- Media can be filter sterilized or pasteurized. Vitamins (in solutions I and IV) should not be heat sterilized.
- Media solutions and vitamin components should be stored in the refrigerator.
- All chemicals should be dated when received and when opened on the bottle.
- Clearly label and date all solutions and chemicals.
- Use aseptic technique in preparation of solutions. Use only clean, sterilized glassware and clean working environments.
- Add stock solution at 20ml/L of seawater for full strength. Add 10ml/L for half-strength, which has been found to be suitable for kelp.
- Germanium dioxide is another, separate component that is added to cultures to prevent growth of diatoms. The solution can be prepared in advance and refrigerated. This solution is added at 2ml/L of water.
- For Kelp Culture: 20 gallon tank ~ 75 Liters. ½ strength PES = 750 ml/week per tank

PES Ordering Information

All chemicals are listed with Fisher Scientific (Thermo Fisher Scientific Inc., (<http://www.fishersci.com>) ordering number, but other chemical companies are available with competitive pricing, including Sigma-Aldrich. Order information is intended as a guide to assist in finding chemicals.

Solution I: Base Solution	Ordering info	FISHER SCIENTIFIC	SIGMA-ALDRICH
NaNO ₃	Sodium nitrate (granular)	#S342-3 (3kg)	S8170-250G
Na ₂ glycerophosphate	Sodium glycerophosphate	#21655-100G (10g)	G9422-10G
Thiamine-HCl (Vit. B1)	Thiamine hydrochloride	#AC14899-0100 (10g)	T1270-25G
Tris Buffer (CH ₄ H ₁₁ NO ₃)	Tris hydroxymethyl aminomethane	BP152-500 (500g)	T1503-500G
Solution II: Fe (as EDTA complex; 1:1 molar)			
Fe (NH ₄) ₂ (SO ₄) ₂ · 6H ₂ O	Ferrous ammonium sulfate	I77-500 (500g)	F1543-500G
Na ₂ EDTA	Disodium ethylenediamine tetraacetate	BP S311-100 (100g)	E6635-100G
*1 ml of this solution = 0.1 mg Fe. We have recently found that we can substitute 403 mg FeNaEDTA (=C ₁₀ H ₁₂ FeN ₂ NaO ₈ ; molecular weight 367.05)			
Solution III: P II metals			
H ₃ BO ₃ (Boric Acid)	Boric acid H ₃ BO ₃	A74-500 (500g)	B6768-500G
FeCl ₃ · 6H ₂ O	Ferric chloride hexahydrate	ICN19404580 (100g)	236489-100G
MnSO ₄ · H ₂ O*	Manganese sulfate monohydrate	M113-500 (500g)	M7899-500G
Na ₂ EDTA	Disodium ethylenediamine tetraacetate	S311-100 (100g)	E6635-100G
CoSO ₄ · 7H ₂ O	Cobaltous sulfate heptahydrate	C386-500 (500g)	C6768-100G
ZnSO ₄ · 7H ₂ O	Zinc sulfate, 7-hydrate, crystal	AC42460-5000 or JT Baker Chemical Co. #4382-01 (500g)	Z0251-100G
Solution IV: Vitamins			
Vitamin B ₁₂		IC-N10327101 (1g)	V2006-1G
Biotin		AAA1420703 (1g)	B3399-100MG

*Can substitute MnSO₄ · 4H₂O (164mg per 1000mL) *OR* MnSO₄ · 7H₂O (187mg per 1000mL)

Sigma-Aldrich offers smaller-volume bottles online, for a lower total start-up cost, but the online prices of both Fisher and Sigma are comparable, at an estimated \$2.85 per Liter PES (Sigma) to \$2.95 per Liter PES (Fisher).

PES nutrient media is added at 10mL/L seawater, so 1 liter of PES will provide for 100 liters of seawater. This works out to an estimated 3 cents (\$0.03) cost for every 1 liter of seawater used for kelp culture.

VON STOSCH'S ENRICHED SEAWATER MEDIUM

von Stosch's Enrichment (as cited by Ott, 1966)

The seawater should be filtered (Whatman's #1) to remove large organic particles and sand. Then sterilize by autoclaving (time: 100 ml requires 10 minutes; 2 liters requires 40 minutes; 3 liters requires 50 minutes; and 5 liters requires 70 minutes).

To each liter of seawater, then add the following:

Salts	1 liter of seawater
(1) NaNO ₃	42.50 mg
(2) Na ₂ HPO ₄ · 12H ₂ O	10.75 mg
(3) FeSO ₄ · 7H ₂ O	278.00 µg
(4) MnCl ₂ · 4H ₂ O	19.80 µg
(5) Na ₂ EDTA · 2H ₂ O	3.72 mg
Vitamins	
(6a) Thiamine-HCl	0.20 mg
(6b) Biotin	1.00 µg
(6c) B ₁₂	1.00 µg

It is convenient to prepare a stock solution of each salt in distilled water; of such concentration that 1 ml of the stock solution gives the required concentration of each ingredient. The three vitamins may be incorporated in the same stock solution, which should be refrigerated. The salts and vitamins after preparation into stock solutions should be filter sterilized.

- I. To make stock solutions use deionized distilled water and clean volumetric flasks.
- II. Filter each stock solution through separate 0.22 µm Millipore filters. Each solution will have to be sterilized separately.
- III. Aseptically pour filtered volume of liquid into autoclaved stock bottles.

1-liter stock solution	2-liter stock solution
(1) 42.500 grams	85.000 grams
(2) 10.750	21.500
(3) 0.278	0.556
(4) 0.0198	0.039
(5) 3.720	7.440
(6a) 0.200	0.400
(6b) 0.001	0.002
(6c) 0.001	0.002

Modified Von Stosch Enrichment (VSE) for use with red algae			
*It is convenient to prepare a stock solution of each salt in distilled deionized water using the table below. Then add 1 ml of each solution, 1-6, to 1 L of sterilized seawater. It is suggested to combine solutions 3 and 4 just prior to this addition to the sterilized seawater. Salts and vitamins solutions should be sterile filtered after their preparation—see notes on next page.			
Solution Components			
Ingredients			
<u>Solution 1: Nitrogen</u>	Quantity (grams)	Quantity (X2)	Quantity (X3)
Deionized water	1L	2L	3L
Ammonium chloride (NH ₄ Cl)	26.75 g	53.49 g	80.24 g
<u>Solution 2: Phosphate</u>			
	Quantity (grams)	Quantity (X2)	Quantity (X3)
Deionized water	1L	2L	3L
Sodium phosphate. dibasic, 12-hydrate, crystal (Na ₂ HPO ₄ .12H ₂ O)	0.4 g	0.8 g	1.2 g
<u>Solution 3: Iron*</u> (Combine with 4 immediately prior to addition to seawater)			
	Quantity	Quantity (X2)	Quantity (X3)
Deionized water			
Ferrous sulfate (FeSO ₄ .7H ₂ O)			
<u>Solution 4: EDTA*</u> (Combine with 3 immediately prior to addition to seawater)			
	Quantity	Quantity (X2)	Quantity (X3)
Deionized water			
Disodium ethylenediamine tetra acetate (Na ₂ EDTA)			
<u>Solution 5: Manganese</u>			
Deionized water	1L	2L	3L
Manganese chloride . 4H ₂ O (MnCl ₂)	0.0198 g	0.0396 g	0.0594 g
<u>Solution 6: Vitamins*</u> (Store in freezer)			
	Quantity	Quantity (X2)	Quantity (X3)
Deionized water	1L	2L	3L
Thiamine	0.2 g	0.4 g	0.6 g
Biotin	0.001 g	0.002 g	0.003 g
Vitamin B ₁₂	0.002 g	0.004 g	0.006 g

Notes on VSE preparation

- The original source of nitrogen for VSE is sodium nitrate (NaNO_3). This can also be used at 42.5 g per 1 L of deionized water. The original source of phosphate for VSE is $\text{Na}_2 \beta$ -glycerophosphate. This can be substituted at 6.48 g per L of deionized water.
- Prepare all six solutions separately using clean sterilized volumetric flasks, clean pipettes, digital balance, and mix with magnetic stirring bars.
- Filter sterilize each solution using a 0.2 μm filter and a vacuum pump assembly. Vitamins should not be heat sterilized.
- Media solutions should be stored in the refrigerator, vitamins (solution 6) should be stored in the freezer and thawed for use.
- All chemicals should be dated when received and when opened on the bottle.
- All solutions should be clearly labeled at every step, and aseptic technique should be used in preparation.
- It is easiest to make up large amounts of the solutions initially, then aliquot out usable amounts in smaller bottles (well sealed) for convenience. The prepared bottles can then be kept ready in the refrigerator for water changes.
- Full strength is 1ml/L.
- Germanium dioxide is another, separate component that is added to cultures to prevent growth of diatoms. The solution can be prepared in advance and refrigerated. This solution is added at 2mL/L of water.
- All glassware should be sterilized, and the working space should be very clean and include a flame of some sort to prevent contamination of this high nutrient media.

Nutrient Media Supplies Checklist

Media preparation	
Glassware: (Pyrex)	
	Volumetric flask (1000mL; measuring)
	Erlenmeyer flasks (3000mL; mixing and storing)
	Graduated cylinders (500 or 1000 mL)
	Storage flasks and bottles
	Digital scale (0.0001 g; 3 decimal places)
	Weigh paper/boats
	Metal chemical spoon or spatula (measuring)
	Safety goggles and gloves
	0.2 micron filter for media sterilization (Corning Disposable Sterile Bottle Top Filter, 150mL Funnel, #25965-45)
	Pyrex screw-cap media storage bottles (media storage)
	Clean work space
	Flame (for sterile technique; Bunsen burner, etc)
	Sterile pipettes, 10mL (measuring; disposable plastic or glass autoclavable)
	Pipette bulb or motor
	pH meter and associated buffers
	Stirring plate and magnetic stir bars
	Parafilm

General Culture System Materials and Estimated Costs		
Item	Base	
Seawater System		
Seawater filters—3-step cartridge system, down to 1 micron		Online, hardware stores
Filter cartridge housings	40	Pentek Blue
Filter cartridges (20, 5, 1 micron size)	20	Pentek
Seawater holding tank system		
500-gallon plastic holding tank	400	Ace Roto-mold
UV light for seawater sterilization	400	Smart UV Sterilizers/Emperor Aquatics
External water pump to circulate water	200	http://marinedepot.com
Round polyethylene or fiberglass tanks, various sizes	200-2000	Pentair Aquatic Eco-Systems Inc.
2 20-gallon high (24x12x16") fish tanks	45	
Aquarium Chiller	500-800	Ecoplus Water Chiller: Sunlight Supply; Seachill Aquarium Refrigeration Unit: Pentair Aquatic Eco-Systems Inc.; aquarium suppliers
MD3 pump, mag drive pump, 350 gph, 35 W	62	Pentair Aquatic Eco-Systems Inc.
Water tubing 50' coil	130	http://www.PentairAES.com
Laboratory		
Polycarbonate or glass 10L clear autoclavable carboys	50-200	Laboratory, homebrewing suppliers
Flasks	30-100	Laboratory suppliers
Petri dishes	100	
Forceps	50	
Microscope	100-600	
Pasteur pipettes	20 (box of 200)	http://www.sigmaaldrich.com
Digital Scale	60-200	General lab supply
Temperature and power alarm and auto dialer	330	Omegaphone. http://www.omega.com
Lights		
CW-HO fluorescent lamps - high output - cool white		Greenhouse growers supply
Light bulbs & fixtures	200	Lighting Suppliers
Photoperiodic timers	30	Aquarium, Hardware supply
Neutral density screening for light adjustment (roll of window screen)	15	Hardware stores
Aeration		
Aquarium aeration pumps	30	Aquarium Supply
Aeration tubing, small diameter, 25'	6	Aquarium Supply
Rigid aeration tubing for large tanks, large diameter	30	Aquarium, Aquaculture Supply
Hepa-vent inline air filters (pack of 10)	80	General lab supply
Glass tubing for aeration	20	General lab supply

Glossary

All definitions are from the text or courtesy of Dr. Arthur C. Mathieson, except where indicated

Aeration. Providing air to a culture, at any size. This is typically achieved by pumping air through bacterial air vents into culture vessels or tanks.

Agamospore¹. An unfertilized spore (i.e. asexual) formed by the blade that develops into conchocelis.

Agar. A phycocolloid; a sulfated polysaccharide (i.e. a galactan) found in the cell walls and intercellular spaces of different Rhodophyta (e.g. *Ahnfeltia*, *Gelidium*, *Gracilaria*).

Agarophyte. A species of red seaweed that contains agar (e.g. *Gracilaria* spp.).

Algae. Latin word for seaweed; autotrophic organisms with unprotected reproductive cells and exposed zygotes.

Alginate. A phycocolloid; a sulfated carbohydrate extracted from brown algae (e.g. *Ascophyllum*); also a general term for salts of alginic acid.

Annual. Plant/seaweed that only lives one growing season. In some species, one life stage can be an annual and one a perennial (e.g. *Pyropia leucosticta*: blade is annual, conchocelis is perennial).

Antheridium (antheridia). The male reproductive organ (gametangium) that produces flagellated sperm in oogamous sexual reproduction.

Apical (Apical cell). At the tip; the terminal initial cell.

Archeospore¹. An unfertilized spore (i.e. asexual) formed by the blade (1 per cell) that germinates into the blade.

Asexual. No sexual fusion in reproduction (cf. apomictic).

Axenic. Pure or sterile (culture).

Bioextraction. The process of removing nutrients (inorganic in the case of seaweeds, organic in the case of shellfish) from the water column. This can occur either in open-water systems or in closed land-based recirculating tank systems.

Bioremediation. See “Bioextraction”.

Blade. A flattened leaf-like structure (e.g. frond).

Boundary layer. Stagnate layer that forms adjacent to cells in the absence of disturbance or current.

Carotene. Pigments with oxygen-free, unsaturated hydrocarbons that are fat-soluble and reflect yellow, orange, or red light.

Carotenoid. A general term for carotenes and xanthophyll pigments that are long hydrocarbon molecules with terminal benzene rings.

Carrageenan. A phycocolloid or a sulfated polysaccharide found in the cell walls of some red algae (see *Eucheuma* and *Hypnea*).

Carrageenophyte. A species of red seaweed that contain carrageenan (e.g. *Chondrus crispus*).

Carpogonium. A female sexual cell in red algae with a basal gamete and an elongated apical receptive part (the trichogyne).

Carposporophyte. The diploid, partially parasitic phase attached to the female gametophyte in the triphasic red algae life history; it develops by mitotic divisions of the zygotic nucleus.

Carpospore. A spore released from carposporangia; typically it is diploid.

Conchocelis. A filamentous phase of some Bangiophycidae consisting of filaments that grow in dead calcareous shells.

Cortex. The outer tissue of a thallus and is usually made of compact cells or filaments with plastids if there is no epidermis.

Compound microscope. A light microscope that has two lens (an objective and an eyepiece).

Cruciate. Division of a tetrasporangium where the first and second cleavages are perpendicular to each other.

Cystocarp. The gonimoblast tissue and surrounding gametophytic pericarp tissue; the structure in which carpospores are formed.

Desiccation. Drying as a result of removal from water (in the case of seaweeds).

Diatom. Phytoplankton (microscopic) that cell wall made of silica. They typically have a golden pigmentation and come in a variety of morphologies.

Dichotomous. With two equal branches at each fork (cf. bifurcate).

Dioecious. With male and female organs on separate algae; unisexual.

Diploid. Having double the haploid number of chromosomes.

Dissecting microscope. A microscope with low magnifying power that is used to examine small plant parts (e.g. isolate spores).

Endophytic. Growing within the tissues or sheath of an alga.

Endospore¹. An unfertilized spore (i.e. asexual) formed by the blade, arranged irregularly, that develops into a blade.

Epilithic. Growing on rocks or other hard substratum.

Epiphytic. Growing on the surface of another plant and not parasitic.

Euryhaline. Able to tolerate a wide range of salinities.

Exogenous. Formed at the surface or arising externally.

Extensive. Low inputs (nutrients, light, etc) and labor.

Fragmentation. Division involving splitting or breaking into parts.

Fronnd. The part of the thallus other than the attachment structure.

Gametophyte. A thallus, usually haploid, that produces gametangia.

Haploid. Having one set (n) of chromosomes, half the diploid number.

Herbarium sheet. A paper with a dried, pressed sample for identification or records.

Heteromorphic. Having morphologically dissimilar forms within a life history (e. g. haploid plants gametophytes and diploid sporophytes).

Holdfast. Basal attachment structure of one to many rhizoids.

Inorganic. Elements, molecules, or compounds that do not arise from biological activity or natural growth (e.g. oxygen atom, water molecule, dissolved nitrogen, phosphorus).

Integrated multi-trophic aquaculture (IMTA). An ecologically-friendly aquaculture concept where the waste production of fed species (i.e. fish or shrimp) is coupled with the extractive capabilities of species such as seaweeds (inorganic nutrients) and shellfish (organic nutrients). In practice, IMTA minimizes or lessens the environmental impact of fed crop aquaculture (Neori *et al.* 2007).

Intensive. High inputs (nutrients, light, etc) and labor.

Intercalary. Any position in a thallus other than the apex or base.

Intertidal. Growing between extreme high and low water levels.

Isomorphic. Of the same morphology (e.g. different life history phases).

Kelp. Common name for members of the Laminariales, derived from the Latin word “lamina” meaning thin sheet.

Life cycle or history. Sequence of morphological and nuclear phases of an organism.

Macroalgae. Large algae easily observed without a microscope.

Media. The material that a plant or sea plant is grown in. In the case of seaweeds, this entails seawater and nutrients, which are added to the seawater to enhance growth.

Medulla. The central colorless tissue, filamentous, pseudoparenchymatous, or parenchymatous in construction of an axis or thallus; also a pit.

Meristem. A group or region of dividing cells that initiate growth.

Microscopic. Not visible to the unaided eye; requiring magnification.

Meiosis¹. Reduction division, where cells divide and each daughter cell has half of the chromosomes of the parent cell.

Meiospore. A spore produced by meiosis.

Mitosis¹. Cell division in eukaryotic cells, where each daughter cell is identical to the parents cell.

Monoecious. One household; with male and female gametangia on the same thallus.

Neutral spore¹. An unfertilized spore (i.e. asexual) formed by the blade cells that develops back into a blade.

Nutrient loading. The addition of excess nutrients (in particular nitrogen and phosphorus) to the aquatic environment.

Oogonium. A single celled female gametangium with one or more eggs.

Organic. Related to or derived from living matter (e.g. feces and pseudo feces).

Perennial. A plant/seaweed that survives more than one growing season, typically more than two years. In some species, one life stage can be an annual and one a perennial (e.g. *Pyropia leucosticta*: blade is annual, conchocelis is perennial).

Photoperiod. The amount of light and dark in the day. For example, a light on a 16: 8 L:D cycle would have 16 hours of light and 8 hours of dark.

Phycobilins. A group of protein-bound, water-soluble pigments in members of the Cyanophyta and Rhodophyta; the pigments reflect red and blue light.

Phycocolloid. Colloidal, mucilaginous substances in cell walls of seaweeds (e.g. agar, carrageenan, laminaran) that are used commercially for their stabilizing, thickening and gelling properties.

Photosynthetically active radiation (PAR). The visible portion of the light spectrum (400-700 nm). These are the wavelengths of light that are available to photosynthetic organisms (plants and sea plants) to power photosynthesis.

Polymorphic. With variable morphologies or appearances.

Refractometer. A hand-held instrument to measure salinity.

Rhizoid. A down growing hyphal-like uniseriate filament that functions in attachment or thickens the axis (e.g. rhizoidal filament).

Sea vegetable. Seaweed that is harvested for human consumption.

Spermatia. Non-motile or amoeboid colorless male red algal gamete.

Sorus. An aggregation of reproductive structures.

Sporophyte. A morphological phase in a life history that produces spores.

Stocking density. The amount of seaweed tissue per area of tank space.

Subtidal. Below the low tide mark (i.e. never exposed by the tide).

Tetrasporangium. A unilocular sporangium in which four spores are produced by meiosis.

Tetraspore. A single spore of a tetrasporangium produced by meiosis.

Tetrasporophyte. A diploid phase in a life history of a red alga that bears tetraspores, usually via meiosis.

Trichogyne¹. A hair-bearing cell.

Triphasic. A life history in some red algae that has three morphological phases: gametophytic, carposporophytic and tetrasporophytic.

Unialgal culture. Containing only one algae (i.e. only the cultured species, free of other algal contaminants).

Vegetative. Cells or tissue produced via mitosis and not associated with sexual reproduction.

Zygote¹. The product of the fusion of two gametes.

Zygotosporangium¹. A sporangium (reproductive structure) resulting from cell division of the zygote (i.e. fertilized cell), which produces diploid (two sets of chromosomes) spores known as zygotospores.

Zygotospore¹. A diploid spore formed in a zygotosporangium, which germinates into conchocelis in the life history of nori.

¹For more information, please refer to Brodie and Irvine, 2003.

Index

- aeration 21, 29, 36, 39, 42, 48, 64
- Alaria esculenta* 7, 17, 18
- asexual (vegetative) propagation: 34, 38, 43, 55, 57
- autoclaving 9, 10, 15, 47, 61
- bioextraction systems 6
- biomass production 33, 38
- bottom culture 33, 41
- carospore 33, 36, 42, 44, 46,
- carrageenan 4, 43, 49, 51, 52
- Chondrus crispus* 43-53
- conchocelis 58-59
- conchospore 57, 58
- cultivation 20, 33, 45, 58
- culture initiation 22, 33, 34
- culture plan 27
- culture system 8, 38, 49, 63
- cystocarp 47
- diatoms 11
- diseases 51
- epiphytes 41, 47, 51
- field culture 22, 26, 40
- flow-through systems 50
- Gracilaria* 31-42
- Gracilaria* lab culture 37
- Gracilaria* life cycle 32
- Gracilaria tikvahiae* 31
- IMTA 6, 52, 62-64, 66
- inoculation 24
- integrated multi-trophic aquaculture 6, 62-64, 66
- Kelp 17-30
- Kelp culture conditions 29
- kelp life cycle 19
- laboratory equipment 14
- Laminaria digitata* 17
- life history
 - Chondrus crispus* 44
 - Gracilaria* 32
 - Kelp 25
 - Nori 58
- lighting 12, 13, 45, 76
- marine aquaculture production 6, 55
- mixed culture methods 42
- net seeding 59
- Nori 54-68
- nutrient media 21, 45, 62, Appendix
- nutritional requirements 51, 67
- open water cultivation 53
- pests and weeds 51, 65
- plant agitation 50
- Porphyra* 54-68
- processing wild-collected material 23, 46, 61
- PVC spools 21, 26
- Pyropia* 54
- rope culture 26, 30, 40
- rotary wheel 59
- Saccharina latissima* 4, 7, 17-30

INDEX continued

salinity 8, 14, 20, 29, 40, 46
seawater exchange 20, 50, 65
seed string kelp 20; nori 59
seeded nets nori, 59
seeded spools (kelp) 21, 26
seeding (*Gracilaria*) 42
sexual propagation 20, 32-33, 37, 42, 43
sorus tissue 18, 19, 23-24
spore isolation/release 25, 36, 42, 47, 61, 63
sporeling coalescence 44
sterilization 9 (see also autoclaving)
stocking density 39, 41, 51, 65
strain selection 49, 63
tank culture systems 38, 49, 50, 52, 64, 67
temperature 9, 10, 12-13, 18, 21, 24-26, 29, 31,
40, 46, 49, 51, 53, 58, 60
tip Isolation 34, 48
tumble culture 30
vegetative culture 27, 28 (see also asexual)
Von Stosch Enriched Seawater 45, 47, Appendix
Wild-sourced seed 22
Wildemanian amplissima 56